



Hot Cupboard  
- Plain Top  
(Operator Side)

Hot Cupboard  
- Plain Top  
(Customer Side)

## ABOUT

This durable heated storage cupboard forms part of the Glide range of mobile dining carts - a choice of cold, hot & ambient commercial catering carts that combine to form a food service counter solution as unique as your requirements!

The hot cupboard (no gantry) features a fan blown heating assembly which evenly distributes heat around the space. The hot cupboard is made in 4 different sizes to suit your service layout. The model features a s/steel plain work surface and a rear store cupboard under.

Behind lift-off rear sliding s/steel cupboard doors, are two tiers of removable, height adjustable grid shelves for plate/ container storage. The wire shelves help distribute heat around the cupboard and support plate holding, dish storage or up to ten 1-1 Gn size (150mm deep) gastronorm containers (not included), depending on cupboard size.

The front/side base panels are finished in leathergrain plastisol steel, colour merlin grey (BS 18B25). Each model comes with lockable castors.

## ACCESSORIES & FINISHES

### Folding Steel Solid or Tubular Tray Slides.

Drop down tray rails or slides + 40mm (d) height = (h) - 55mm.

### Selection Of Colour Finishes To Bases.

11 alternative choices of durable steel, colour & wood effect for the external front/ side base panels.

## HEIGHT OPTIONS

### Low Height Model (Glide Junior).

850mm or 800mm high options for junior/ primary use.



## GANTRY OPTIONS

Download All Technical Drawings From [www.cedfabsltd.co.uk](http://www.cedfabsltd.co.uk)

### Heated Gantry.

Heated gantry option provides short term hot holding of plated meals under.

**Ambient/ Island Or Deli Gantry.** LED reversible glass gantry or island gantry options can be added to increase food presentation space. The deli gantry option also includes a glass mid-shelf.

## FEATURES

### Model Type.

The Glide hot storage cupboard is a mobile plain top heated storage station with external full front/ side fascia panels, a s/steel worktop & a two tier wire rack shelf hot storage cupboard behind. Each shelf is adjustable in height and fully removable for cleaning. The operator side rear s/steel sliding doors are also removable.

### Model Dimensions.

The hot cupboard is available as 2-1Gn (825mm), 3-1Gn (1175mm), 4-1Gn (1525mm) & 5-1 Gn (1875mm) long x 700mm (D), 900mm (H) & fitted with lockable heavy duty castors.

### Model Finishes.

Base and outer end panels in plastisol steel, colour merlin grey. The worktop is made from 304 gd s/steel & the rear facing internal surfaces are in 430gd.s/steel.

### Low Maintenance.

Easy, cleanable surfaces and a durable design ensure low maintenance for users.

### Finishes & Options.

The cupboard can be customised with many accessories such as tray slides, tray rails, colour finishes, heated/ ambient or deli gantries and also low height versions for junior/ primary age use.

A wall sited version of this cupboard is also available, for alcoves or recesses, c/w front facing sliding s/steel doors, gantries & colour finishes for the base cupboard rear and sides. (See separate model GWSHCP2-5).

### Power Supply.

The cupboard is supplied with a 3m lead & 13 amp UK plug (13A 230v 50Hz).

**Equipment Conformity.** CE & UKCA Certified equipment.

### Temperature Controls.

The fan assisted hot cupboard features thermostat control. Gantry options & mains power are operated by individual neon indicator switches.

(See Below)

(Plain Top Hot Cupboard)



HC Power

(Plain Top Hot Cupboard & Gantry)



HC Gantry Power



Operator Side

Customer Side

## Glide Hot Cupboard (Plain Top)

Code	Description	Capacity (Gn)	Dimensions (L x D x H mm)	Depth With Tray Slide Up/ Down	Weight (kg)	Total Power (kW)		
						No Gantry	+ Hot Gantry	+Amb. Gantry
GHCP2	Glide Plain Top Hot.Cupd No Gantry	2-1	825 x 700 x 900	1000/ 740mm	45	0.93	1.33	0.93
GHCP3	Glide Plain Top Hot.Cupd No Gantry	3-1	1175 x 700 x 900	1000/ 740mm	67	0.93	1.53	0.94
GHCP4	Glide Plain Top Hot.Cupd No Gantry	4-1	1525 x 700 x 900	1000/ 740mm	90	0.93	1.73	0.94
GHCP5	Glide Plain Top Hot.Cupd No Gantry	5-1	1875 x 700 x 900	1000/ 740mm	112	1.43	2.43	1.45

**Model Description.** Glide mobile dining cart, plain top hot cupboard (no gantry), electric, 700(d) x 900(h), fan assisted heating with removable rear sliding s/steel cupboard doors & internal grid shelves for plate/ Gn container holding. Cupbd. accommodates 1-1 Gn 150mm (d) containers (not included). Front/side base panels in leathergrain plastisol steel, colour merlin grey (BS 18B25), lockable castors, control panel to operator side, 3m lead, 13A UK plug top. H/cupb. has thermostat control & neon mains power on/off switch. Gantry options are controlled by neon on/off switch. Supply 230V 50Hz 13A. (Gantry/ Tray Rails Optional)

## Glide S/Steel Folding Tubular Tray Rail

Code	Description	Capacity (Gn)	Dimensions (L x D x H mm)	Weight (kg)
GTTS2	Glide S/Steel Drop Down Tray Rail	2-1 Gn	825 x 298 x (base-55)	2
GTTS3	Glide S/Steel Drop Down Tray Rail	3-1 Gn	1175 x 298 x (base-55)	3
GTTS4	Glide S/Steel Drop Down Tray Rail	4-1 Gn	1525 x 298 x (base-55)	5
GTTS5	Glide S/Steel Drop Down Tray Rail	5-1 Gn	1875 x 298 x (base-55)	7

## For Hot Cupboard (Plain Top)

### Option Description.

S/steel tubular tray rail, 304 gd. Ø25 tube, drop down bracket type, up position depth + 298 mm to base unit, down position depth + 40mm to base unit. Trayslide height = base unit (h) - 55mm.

## Glide S/Steel Folding Solid Tray Slide

Code	Description	Capacity (Gn)	Dimensions (L x D x H mm)	Weight (kg)
GSTS2	Glide S/Steel Drop Down Solid Tray Slide	2-1Gn	825 x 302 x (base-55)	3
GSTS3	Glide S/Steel Drop Down Solid Tray Slide	3-1Gn	1175 x 302 x (base-55)	5
GSTS4	Glide S/Steel Drop Down Solid Tray Slide	4-1Gn	1525 x 302 x (base-55)	7
GSTS5	Glide S/Steel Drop Down Solid Tray Slide	5-1Gn	1875 x 302 x (base-55)	9

## For Hot Cupboard (Plain Top)

### Option Description.

S/steel solid tray slide, drop down bracket type, up position depth + 302 mm to base unit, down position depth + 40mm to base unit. Trayslide height = base unit (h) - 55mm.

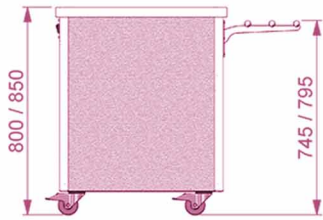

### Low Height Model (Glide Junior) - 800/ 850mm (h)

Code	Description	Base Height (mm)	Optional Tray Slide Height (mm)
G800H**	Glide Base Unit 800mm Height	800	745
G850H	Glide Base Unit 850mm Height	850	795

\*\*G800H Bespoke Option (With Extended lead Time)

### For Hot Cupboard (Plain Top)

#### Option Description.

Lower height option codes for junior/ primary use.

**\*\*800mm (h) base unit, c/w 100mm lockable castors.**  
(Optional trayslide height becomes 745mm high)\*\*

**850mm (h) base unit, c/w 100mm lockable castors.**  
(Optional trayslide height becomes 795mm high).

### Colour Finishes To Base Panels (Front & Sides)

Option Description. 11 choices of leathergrain plastisol steel colours/ wood effect laminated steel for front fascia panel/ external ends.

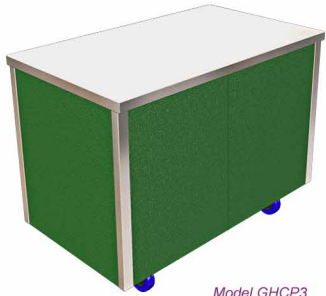

Model GHCP3  
Option GGRENCHA3 Shown



Model GHCP3  
Option GBEECCHA3 Shown

Code	Description	Capacity	Code	Description	Capacity
<b>Ocean Blue (BS 18C37)</b>					
GBLUECHA2	Glide Blue Fascia - Ambient	2-1Gn	GSSTLCHA2	Glide S/Steel Fascia - Ambient	2-1Gn
GBLUECHA3	Glide Blue Fascia - Ambient	3-1Gn	GSSTLCHA3	Glide S/Steel Fascia - Ambient	3-1Gn
GBLUECHA4	Glide Blue Fascia - Ambient	4-1Gn	GSSTLCHA4	Glide S/Steel Fascia - Ambient	4-1Gn
GBLUECHA5	Glide Blue Fascia - Ambient	5-1Gn	GSSTLCHA5	Glide S/Steel Fascia - Ambient	5-1Gn
<b>Goosewing Light Grey (BS 10A05)</b>					
GGREYCHA2	Glide Grey Fascia - Ambient	2-1Gn	<b>Forest Green/Heritage (RAL 6002)</b>		
GGREYCHA3	Glide Grey Fascia - Ambient	3-1Gn	GGRENCHA2	Glide Green Fascia - Ambient	2-1Gn
GGREYCHA4	Glide Grey Fascia - Ambient	4-1Gn	GGRENCHA3	Glide Green Fascia - Ambient	3-1Gn
GGREYCHA5	Glide Grey Fascia - Ambient	5-1Gn	GGRENCHA4	Glide Green Fascia - Ambient	4-1Gn
<b>Poppy Red (BS 04E5B)</b>					
GPREDCHA2	Glide Red Fascia - Ambient	2-1Gn	GGRENCHA5	Glide Green Fascia - Ambient	5-1Gn
GPREDCHA3	Glide Red Fascia - Ambient	3-1Gn	<b>Buttermilk Cream/ Honesty (BS 10C31)</b>		
GPREDCHA4	Glide Red Fascia - Ambient	4-1Gn	GCREMCHA2	Glide Cream Fascia - Ambient	2-1Gn
GPREDCHA5	Glide Red Fascia - Ambient	5-1Gn	GCREMCHA3	Glide Cream Fascia - Ambient	3-1Gn
<b>White (BS 00E55)</b>					
GWHITCHA2	Glide White Fascia - Ambient	2-1Gn	GCREMCHA4	Glide Cream Fascia - Ambient	4-1Gn
GWHITCHA3	Glide White Fascia - Ambient	3-1Gn	GCREMCHA5	Glide Cream Fascia - Ambient	5-1Gn
GWHITCHA4	Glide White Fascia - Ambient	4-1Gn	<b>Black (BS 00E53)</b>		
GWHITCHA5	Glide White Fascia - Ambient	5-1Gn	GBLAKCHA2	Glide Black Fascia - Ambient	2-1Gn
<b>Wood Grain Effect Panels DL85 Walnut Finish</b>					
GWALNCHA2	Glide Walnut Fascia - Ambient	2-1Gn	GBLAKCHA3	Glide Black Fascia - Ambient	3-1Gn
GWALNCHA3	Glide Walnut Fascia - Ambient	3-1Gn	GBLAKCHA4	Glide Black Fascia - Ambient	4-1Gn
GWALNCHA4	Glide Walnut Fascia - Ambient	4-1Gn	GBLAKCHA5	Glide Black Fascia - Ambient	5-1Gn
GWALNCHA5	Glide Walnut Fascia - Ambient	5-1Gn	<b>Wood Grain Effect Panels DL76 Beech Finish</b>		
<b>Wood Grain Effect Panels DL84 Oak Finish</b>					
GOAKCHA2	Glide Oak Fascia - Ambient	2-1Gn	GBEECCHA2	Glide Beech Fascia - Ambient	2-1Gn
GOAKCHA3	Glide Oak Fascia - Ambient	3-1Gn	GBEECCHA3	Glide Beech Fascia - Ambient	3-1Gn
GOAKCHA4	Glide Oak Fascia - Ambient	4-1Gn	GBEECCHA4	Glide Beech Fascia - Ambient	4-1Gn
GOAKCHA5	Glide Oak Fascia - Ambient	5-1Gn	GBEECCHA5	Glide Beech Fascia - Ambient	5-1Gn

### Glide Ambient Gantry c/w LED Lighting (Self Help & A.Serve) For Hot Cupboard (Plain Top)

Code	Description	Capacity (Gn)	Dimensions (L x D x H mm)	Weight (kg)	Power (kW)
GAG2	Glide Amb Gantry S. Help/ A. Service	2-1Gn	825 x 700 x 397	7	0.008
GAG3	Glide Amb Gantry S. Help/ A. Service	3-1Gn	1175 x 700 x 397	9	0.014
GAG4	Glide Amb Gantry S. Help/ A. Service	4-1Gn	1525 x 700 x 397	12	0.016
GAG5	Glide Amb Gantry S. Help/ A. Service	5-1Gn	1875 x 700 x 397	16	0.022

Option Description.  
Ambient gantry, s/steel, c/w LED lighting, opaque cover, colour 4000k, reversible single curved glass sneeze screen, self help or assisted serve use, + 397(h) above worktop, end glass.

### Glide Ambient Deli Gantry c/w LED Lighting (Assisted Serve) For Hot Cupboard (Plain Top)

Code	Description	Capacity (Gn)	Dimensions (L x D x H mm)	Weight (kg)	Power (kW)
GADG2	Glide Amb. Deli Gantry A.Serve	2-1Gn	825 x 700 x 540	12	0.008
GADG3	Glide Amb. Deli Gantry A.Serve	3-1Gn	1175 x 700 x 540	17	0.014
GADG4	Glide Amb. Deli Gantry A.Serve	4-1Gn	1525 x 700 x 540	21	0.016
GADG5	Glide Amb. Deli Gantry A.Serve	5-1Gn	1875 x 700 x 540	26	0.022

Option Description.  
Assisted service ambient deli gantry, s/steel, full height single curved glass front, end glass, glass mid shelf (not chilled), c/w LED gantry lighting, opaque cover, colour 4000k, ass. serve use, + 540 mm(h) above worktop.

### Glide Ambient Island Gantry c/w LED Lighting (Self Help) For Hot Cupboard (Plain Top)

Code	Description	Capacity (Gn)	Dimensions (L x D x H mm)	Weight (kg)	Power (kW)
GAIG2	Glide Amb. Gantry Island Glass	2-1Gn	825 x 700 x 397	9	0.008
GAIG3	Glide Amb. Gantry Island Glass	3-1Gn	1175 x 700 x 397	11	0.014
GAIG4	Glide Amb. Gantry Island Glass	4-1Gn	1525 x 700 x 397	13	0.016
GAIG5	Glide Amb. Gantry Island Glass	5-1Gn	1875 x 700 x 397	18	0.022

Option Description.  
Self help island gantry, s/steel, ambient, double curved sneeze screen glass, end glass, c/w LED gantry lighting, opaque cover, colour 4000k, self help use, + 397 mm(h) above worktop.





# Hot Cupboard (Plain Top)

## HOT GANTRY & POPULAR CODES



### Glide Heated Gantry c/w Infra Red Lamps (Self Help & A.Serve)

Code	Description	Capacity (Gn)	Dimensions (L x D x H mm)	Weight (kg)	Power (kW)
GHG2PTHC	Glide H Cupd Hot Gantry - H Duty Top	2-1Gn	825 x 700 x 397	7	0.4
GHG3PTHC	Glide H Cupd Hot Gantry - H Duty Top	3-1Gn	1175 x 700 x 397	9	0.6
GHG4PTHC	Glide H Cupd Hot Gantry - H Duty Top	4-1Gn	1525 x 700 x 397	12	0.8
GHG5PTHC	Glide H Cupd Hot Gantry - H Duty Top	5-1Gn	1875 x 700 x 397	16	1.0

### For Hot Cupboard (Plain Top)

#### Option Description.

Hot gantry, s/steel, reversible single curved glass sneeze screen, self help/ ass. serve use, + 397(h) above worktop, reinforced worktop for heat, fitted with 200w quartz infra-red jacketed safety lamps.



### Glide P. Top Hot Cupbd. (& Tray Slide)

Model Code	Option Code	Description	Total Power (kW)
GHCP2	GSTS2	Glide PT Hot Cupbd. & T/Slide	2-1 0.93
GHCP3	GSTS3	Glide PT Hot Cupbd. & T/Slide	3-1 0.93
GHCP4	GSTS4	Glide PT Hot Cupbd. & T/Slide	4-1 0.93
GHCP5	GSTS5	Glide PT Hot Cupbd. & T/Slide	5-1 1.43

Requires 13A 230V Elec. Socket

### Glide P. Top Hot Cupbd. (& Tray Rail)

Model Code	Option Code	Description	Total Power (kW)
GHCP2	GTTS2	Glide PT Hot Cupbd. & T/Rail	2-1 0.93
GHCP3	GTTS3	Glide PT Hot Cupbd. & T/Rail	3-1 0.93
GHCP4	GTTS4	Glide PT Hot Cupbd. & T/Rail	4-1 0.93
GHCP5	GTTS5	Glide PT Hot Cupbd. & T/Rail	5-1 1.43

Requires 13A 230V Elec. Socket

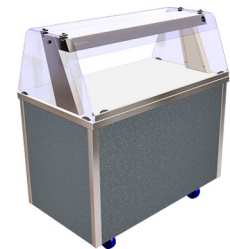

### Glide P. Top Hot Cupbd. (& Amb. Gantry)

Model Code	Option Code	Description	Total Power (kW)
GHCP2	GAG2	Glide PT Hot Cupbd./Amb. Gantry	2-1 0.93
GHCP3	GAG3	Glide PT Hot Cupbd./Amb. Gantry	3-1 0.94
GHCP4	GAG4	Glide PT Hot Cupbd./Amb. Gantry	4-1 0.94
GHCP5	GAG5	Glide PT Hot Cupbd./Amb. Gantry	5-1 1.45

Requires 13A 230V Elec. Socket

### Glide P. Top Hot Cupbd. (& Amb. Deli Gantry)

Model Code	Option Code	Description	Total Power (kW)
GHCP2	GADG2	Glide PT Hot.Cupbd./Amb.Deli Gantry	2-1 0.93
GHCP3	GADG3	Glide PT Hot.Cupbd./Amb.Deli Gantry	3-1 0.94
GHCP4	GADG4	Glide PT Hot.Cupbd./Amb.Deli Gantry	4-1 0.94
GHCP5	GADG5	Glide PT Hot.Cupbd./Amb.Deli Gantry	5-1 1.45

Requires 13A 230V Elec. Socket

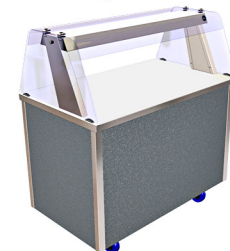
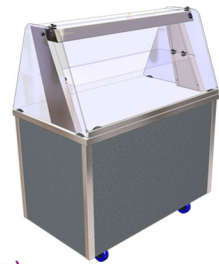

### Glide P.Top Hot Cupbd. (& Amb. Island Gantry)

Model Code	Option Code	Description	Total Power (kW)
GHCP2	GAIG2	Glide PT Hot Cupbd./Island Gantry	2-1 0.93
GHCP3	GAIG3	Glide PT Hot Cupbd./Island Gantry	3-1 0.94
GHCP4	GAIG4	Glide PT Hot Cupbd./Island Gantry	4-1 0.94
GHCP5	GAIG5	Glide PT Hot Cupbd./Island Gantry	5-1 1.45

Requires 13A 230V Elec. Socket

### Glide PT Hot Cupbd. (& Amb. Gantry/Tray Rail/ Colour Fin.)

Model Code	Option Code	Option Code	Option Code	Description	Total Power (kW)
GHCP2	GAG2	GTTS2	GPREDCHA2	Hot.Cupbd./Gantry/T. Rail/(Red)	2-1 0.93
GHCP3	GAG3	GTTS3	GPREDCHA3	Hot.Cupbd./Gantry/T. Rail/(Red)	3-1 0.94
GHCP4	GAG4	GTTS4	GPREDCHA4	Hot.Cupbd./Gantry/T. Rail/(Red)	4-1 0.94
GHCP5	GAG5	GTTS5	GPREDCHA5	Hot.Cupbd./Gantry/T. Rail/(Red)	5-1 1.45

Requires 13A 230V Elec. Socket

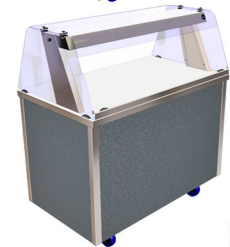

### Glide P.Top Hot Cupd. (& Heated Gantry)

Model Code	Option Code	Description	Total Power (kW)
GHCP2	GHG2PTHC	Glide PT Hot Cupbd./ Hot Gantry	2-1 1.33
GHCP3	GHG3PTHC	Glide PT Hot Cupbd./ Hot Gantry	3-1 1.53
GHCP4	GHG4PTHC	Glide PT Hot Cupbd./ Hot Gantry	4-1 1.73
GHCP5	GHG5PTHC	Glide PT Hot Cupbd./ Hot Gantry	5-1 2.43

Requires 13A 230V Elec. Socket

### Glide PT Hot Cupd. (& Tray Rail/ Colour Finish)

Model Code	Option Code	Option Code	Description	Total Power (kW)
GHCP2	GTTS2	GPREDCHA2	Glide Hot.Cupbd.+ T.Rail + (Red)	2-1 0.93
GHCP3	GTTS3	GPREDCHA3	Glide Hot.Cupbd.+ T.Rail + (Red)	3-1 0.93
GHCP4	GTTS4	GPREDCHA4	Glide Hot.Cupbd.+ T.Rail + (Red)	4-1 0.93
GHCP5	GTTS5	GPREDCHA5	Glide Hot.Cupbd.+ T.Rail + (Red)	5-1 1.43

Requires 13A 230V Elec. Socket

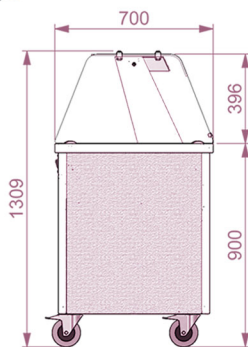
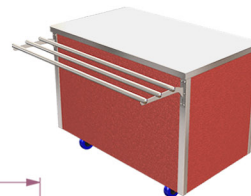

Glide PT Hot Cupbd. (& Amb. Gantry)  
Self Help Position

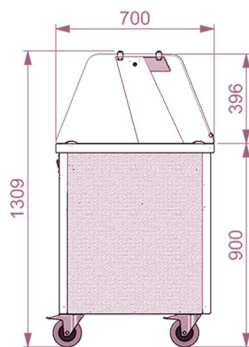

Glide PT Hot Cupbd. (& Amb. Gantry)  
Assisted Service Position

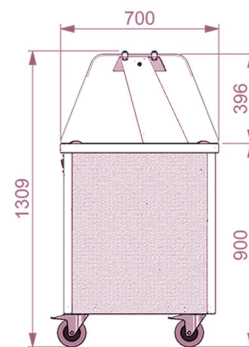

PT Hot Cupbd. (& Amb. Island Gantry)

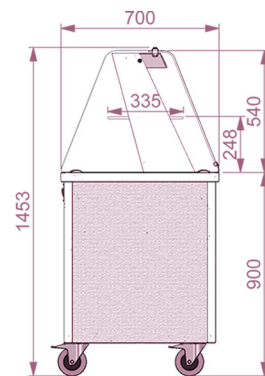

Glide PT Hot Cupbd. (& Amb. Deli Gantry)

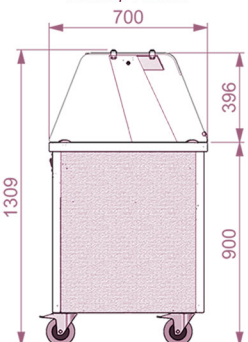

Glide PT Hot Cupbd. (& Heated Gantry)

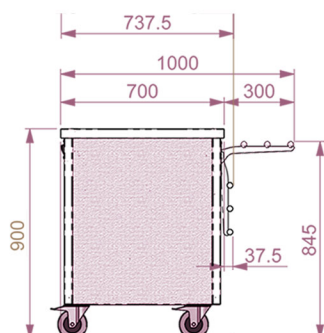

Glide PT Hot Cupbd. (& Tray Rail)

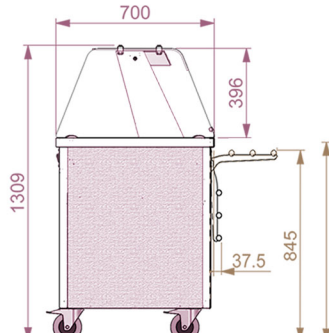

Glide PT Hot Cupbd. (& Gantry/Tray Rail)

