

# User Manual



## Mobile Dining Carts



Chilled ❄️ Heated 🔥 Ambient 🌀



GED



# Index : Glide Mobile Dining Carts



## Glide Heated dining carts

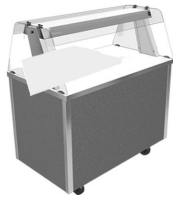

### Plain Top Hot Cupboard - & Gantry Options

Pages	Section
19 - 20	Operation
20 - 21	Maintenance
22	Troubleshooting



### Bain Marie Hot Cupboard (Dry Heat) & Gantry Options

Pages	Section
23 - 24	Operation
25	Maintenance
26	Troubleshooting



### Bain Marie Hot Cupboard (Wet & Dry Heat) & Gantry Options

Pages	Section
27 - 28	Operation
29	Maintenance
30	Troubleshooting



### Ceran Top Hot Cupboard & Gantry Options

Pages	Section
15 - 16	Operation
16 - 17	Maintenance
18	Troubleshooting



### Soup Station (Bain Marie)

Pages	Section
31	Operation
31	Maintenance



### Heated / Ambient Plate Dispenser

Pages	Section
38	Operation
38	Maintenance

## Glide Chilled dining carts



### Cold Multideck & (Shutter Version)

Pages	Section
3 - 4	Operation
5 - 6	Maintenance
13 - 14	Troubleshooting



### Cold Well/Island Well - Cold Deli

Pages	Section
7 - 8	Operation
9 - 10	Maintenance
13 - 14	Troubleshooting



### Eutectic Plate Cold Well/Island Well - Cold Deli

Pages	Section
11	Operation
12	Maintenance



### Optional Drop Down Tray Rail/Slide

Page	Section
21	Operation

## Glide Ambient dining carts



### Ambient Multideck & (Shutter Version)

Pages	Section
32	Operation
33	Maintenance



### Ambient Storage Cupboard & Gantry Options

Pages	Section
34	Operation
35	Maintenance



### Cashier Station - Low Height Tray Pick Up - Cutlery Tray Pick Up - Sanitising Dispenser Unit

Pages	Section
36	Operation & Maintenance

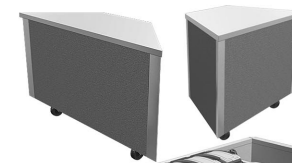

### Waste Clearing Trolley - 45/90° Corner Unit

Pages	Section
37	Operation & Maintenance



## Glide Information

### All Displays

Pages	Section
39	R290 Servicing Information

# Glide Cold Multideck ( & Roller Shutter Version )

## Operation



### A) Switching On The Chilled Merchandiser Display

Ensure the mains power supply is switched on. Switch on the display by pressing the blue **On/ Off** button. The fans and refrigeration unit will start after 30 seconds.

To turn the display lighting on, press the **light** button, a green indicator LED will light up next to the button. The lighting is housed in a diffuser in the canopy head of the display.

### B) Viewing The Pre-Set Operating Temperature Of The Display ( Set Point )

The display is factory pre-set and maintains produce between 0 °c and 5 °c in a maximum 25 °c ambient temperature, 50% relative humidity. The control has a pre-set operating temp. of 2°c which is suitable for most site situations.

To view the set operating temperature :

Press and release the **set** button, a green indicator light will flash next to the button. The control will display the set operating temp. for 10-12 seconds, then reset to show the current cabinet temperature.

### C) Altering The Pre-Set Operating Temperature Of The Display ( Set Point )

Generally, it is **unlikely** that the operating temperature will need to be altered.

To alter the pre-set operating temperature :

Press and release the **set** button, an indicator light will flash next to the button. The control will display the pre-set operating temperature for 10-12 seconds.

Use the **Up** & **Down** buttons to adjust the operating temperature.

\* Adjust by 1°c or 2°c only, allow display to operate for one day before further alterations.

- Press The **Up** button to increase the operating temperature.
- Press The **Down** button to decrease the operating temperature.

### D) Tamper Proof Locking Of The Control Panel

To prevent tampering, the control can be locked. The current temperature of the display and the pre-set operating temperature can be viewed, but not altered by a customer.



#### To Lock The Control Panel :

Press and hold both the UP & Down buttons together until the display flashes '**POF**' to indicate the buttons are now locked.

#### To Unlock The Control Panel :

Press and hold both the UP & Down buttons together until the display flashes '**PON**' to indicate the buttons are now unlocked.

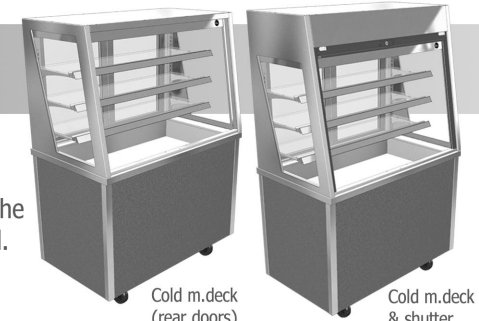

Cold m.deck (rear doors)

Cold m.deck & shutter (rear doors)

### E) What Happens During A Defrost Period ?

The display can run 24 hours a day if required and features pre-set defrost periods. During a defrost period, the display will show '**DEF**' as above.

The condensing unit switches off to allow the cooling coil under the deck to defrost. This process allows any build up of ice around the coil to melt and keeps the cabinet holding temperature correct.

Any ice melting from the coil drains out of the unit and deposits in an evaporation tray, where a heated element turns the water into steam. Movement of air through the condensing unit fan blows this moisture laden air through the grille fitted in the unit. The air is warm and sometimes a 'sizzling' sound can be heard, as defrosted water is being turned to steam. This is perfectly normal.



Cold m.deck & roller shutter (fixed back) has control panel fitted to front, other models fitted to rear.

### F) What The Control Panel LED Symbols Show

A small red light will appear next to each symbol periodically, when the display is in use. The function of these are described below.

#### Defrost Period In Progress -

**DEF** - shown on display - when light flashing, defrost finished & drip time in progress

#### The Cooling Fans Are On -

when flashing, in delay after defrost, will start soon

#### Refrigeration Is On -

when flashing, refrigeration in delay after defrost, will start soon

#### Alarm -

- P1** -Thermostatic Probe Failure
- P2** -Evaporator Probe Failure
- HA** -Maximum Temperature Alarm
- EE** -Data Corruption
- PAL** -Pressure Switch Alarm



**Decimal Point** - for temp. display in °c

If an alarm message shows, please call service department on tel. 01254 238 282

# Glide Cold Multideck ( & Roller Shutter Version )

## Operation Continued

### G) Switching Off The Chilled Merchandiser Display After Serving Period.

At the end of the serving period, the display should be switched off by pressing the blue **On/ Off** button. The LED will display '**OFF**' for appx. 5 seconds & a red 'stand by' light will switch on above the **On/Off** button.

\* Do not isolate the display by turning off at the main switch or plug top, unless maintenance is being undertaken. The drip tray operates at all times, even when the On/Off button is switched off. Defrost water is present in the evaporating tray & isolating the supply may lead to overflow of the tray.

### H) Adjusting The Shelves In Height

1. Take hold of the glass shelf & shelf edge ticket display mounting (attached to the front edge). Lift the glass shelf up and away from the supporting shelf brackets.
2. Tilt the glass shelf and carefully lift it out of the display (or lay on top of the one below)
3. Reposition the brackets at the desired height
4. Clip the brackets to the rear frame like A) for a flat positioned or B) for an inclined position shelf.



### I) Shelf Edge Ticket Display Mounting Assembly

Each shelf is fitted with a ticket display mounting assembly, which allows for the fitting of a standard 40mm ticket strip. The spacing behind the ticket strip helps to maintain the cold air stream or 'air curtain' which passes in front of each shelf. **Do not remove these.**

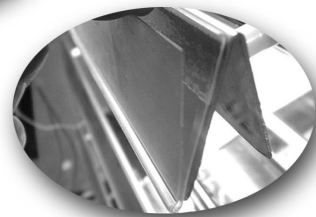

### J) Positioning The Display

To prevent movement the unit is fitted with lockable castors, whether the unit is fixed back (wall sited) or has rear doors (freestanding) the lockable castors are fitted to both customer and operator side. To lock the castor press down on the metal flange above the wheel with the foot. To release the castor/ move the unit, simply flip the lever upwards to release the wheel. (see fig. 1)



fig.1

### K) Rear Access Doors - Operation

If the display has doors, the unit can be loaded from the rear with product.

1. The door is held in the closed position by magnetic gaskets to both top & bottom rear frame and detent action hinges.
2. The hinges allow the door to be held open in two positions, a midway position and fully open.
3. The door has a steel ledge to its' inner face, acting as an infill to the bottom glass shelf when closed, when open, it allows clearance for easier product loading into the deck area.



1. Magnetic Door Gasket



2. Midway Door Position

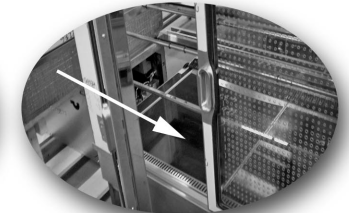

3. Product Loading Deck Access

### L) Recommended Food Display Layout/ Restocking Tips.



#### Food (Deck Or Shelving Area)

Sandwiches, baguettes, rolls, barm cakes, salad, pasta, cheese snacks, cream cakes, pastries, cakes, yoghurt, cereals, fruit in juice & fruit.

#### Drinks (Deck Area For Heavier Items)

Still & carbonated, bottled, canned or cartoned, water, dairy, lemonade, wine, beer, lager, fruit juice & health drinks.



(fig. 2)

#### Overloading Shelves.

Due consideration should be given to overloading if placing drinks on shelving.

#### Allow Air Circulation Space Between Product. (see fig.2)

When re-stocking the cabinet, ensure gaps are present between rows of displayed product - this allows cold air circulation between and prevents obstruction, which may result in freezing occurring at the back of the shelving, or increased temperatures.

#### Multiple Stacking. Multiple stacking should be avoided.

This may also restrict the passage of circulating cold air & increase temperatures (see fig.3).



(fig.3)



# Glide Cold Multideck ( & Roller Shutter Version )



## Maintenance

### M) Switching Off The Chilled Multideck For Maintenance

Before commencing any cleaning or maintenance operation, the display must be isolated from the mains supply by removing the supply plug from the socket.

**N.B. Switching off just using the On/Off button on the control panel does not fully isolate the unit.**

### N) Replacing LED Light Fittings

Parts replacement must be undertaken by a competent installer. The fitting is mounted in the gantry canopy head. The LED light is a low maintenance light with a diffuser cover to protect the led's. To replace the light fitting, complete, including the diffuser, the following procedures must be used.

#### Canopy head:



1. Disconnect the light lead that is attached to the side of the fitting.
2. The complete LED fitting is retained by 2 no. U - shaped clips.
3. Prize open one face of the clip and lift the fitting out & down.

Replacement of the LED light fitting is a reverse of the above process.

### O) Security Roller Shutter: Lock Maintenance.



The multideck may be supplied fitted with a pull down lockable heavy duty security roller shutter. When pushed upwards into the open position (using the ledge on the bottom rail) the shutter is stored in the overhead canopy section.

When pulled down into the closed position and locked, the central lock sends sliding bars into each of the roller shutter guides. Two suited keys are supplied.



Periodic maintenance of the lock itself consists of lubricating the lock barrel occasionally with a maintenance spray (such as WD40).

### P) Achieving Best Performance

1. Introduce product to the display at or below 5°C
2. The display position may effect its' efficiency, beware :
  - \* **High temperatures** in the surrounding room or kitchen.
  - \* **Restricted air flow** to the condensing unit below the display. (see section on 'Cleaning The Condensing Unit Finned Face')
  - \* **Restricted space to front/behind unit**, (e.g. never block the perforated airflow panels) Unit must have clear space in front of the panel to allow clean air in & heat to escape out..
  - \* **Draughts**, common if air conditioning extraction systems are sited above the display.
  - \* **Warm air** from nearby heaters, ovens or cooking equipment.
  - \* **Radiant energy** i.e. direct sunlight or lamps falling directly onto or into the display.
  - \* **Condensation**, can occur if air conditioning systems bring in outside air (not recirculated) or introduce humidity levels above 50% around the display. Environmental conditions should always be below 25°C 50% humidity.

### Q) Cleaning The Main Tank (Below The Display Deck Area)

Routine deep cleaning of the display after product leaks etc. may involve cleaning of the main tank below the deck plates. A competent person can carry out this operation & the following procedure must be used. Fully isolate the display, as described in Maintenance section (Item M), then decant the unit of produce :



1. Lift out the deck plates.
2. This will expose the fan deck below.
3. Remove the screws at each end of the fan deck.
4. Lift out the fan deck.
5. Stand fan deck to one side, so as not to damage fan cable beneath.
6. The tank base & coil cover can be cleaned using a damp cloth & mild detergent.

### R) General Cleaning

Once isolated, stainless steel surfaces can be cleaned with a non abrasive cream cleaner or a damp cloth with a mild detergent. Never hose down, wash or rinse electrical parts.

# Glide Cold Multideck ( & Roller Shutter Version )

## Maintenance Continued

### S) Cleaning The Condensing Unit 'Finned Face' - Monthly Intervals

The condensing unit is mounted under the display & chills the coil under the deck. It has a finned coil or 'face' where air is taken into the unit. These fins become choked with dust & airborne particles. The 'finned face' of the condensing unit must be cleaned **monthly** or the efficiency of the display will not be maintained.

**If the operation is neglected, a new condensing unit may be required.**

Before commencing any cleaning or maintenance operation, the display must be isolated from the mains supply by either removing the supply plug from the socket or switching off at the local consumer board (MCB). The following procedure must be used:

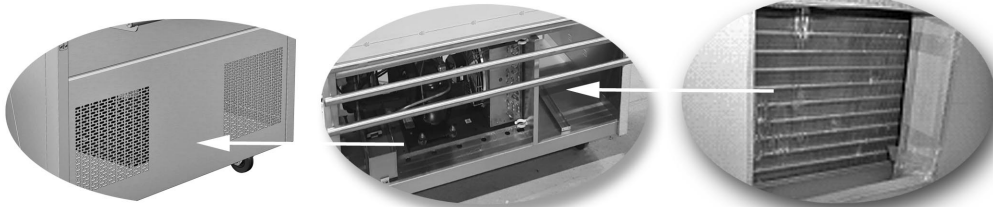

1. Lift off the ventilated metal panel at the front or back.
2. This exposes the condensing unit behind.
3. The fins look like the front of a car radiator and attract dust.



4. Clean the fins using a soft brush to loosen the dust and a vacuum to remove the dust.

### T) How The Cold Air Curtain Guide Works (Honeycomb sheet)

The cold multi deck keeps food cold by allowing cold air to travel up the rear doors or steel perforated back panel. Some of the cold air spills out on to the shelves. The remainder is pushed through the top of the unit and comes out in the canopy section. The air passes through the honeycomb sheet here & down in front of each shelf forming an 'Air Curtain' & trapping the cold air on the shelf. The ticket strip holders fit to the front edge of the glass shelf allowing 40 mm (h) price strips to be fitted. They also form a product stop preventing food interfering with the flow of cold air from above.

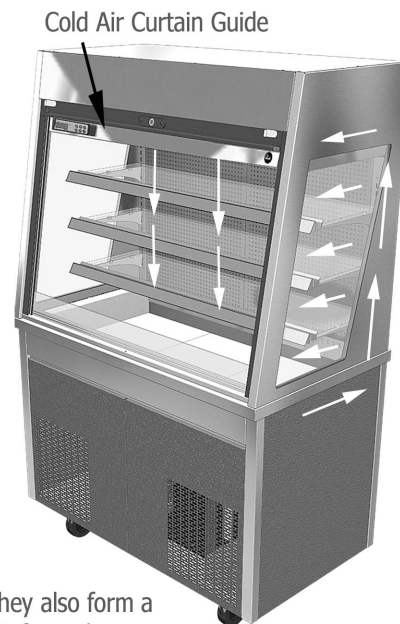

### U) Cleaning The Cold Air Curtain Guide - 3 Monthly Intervals (Honeycombe Sheet)

The following procedure should be used. After isolating the unit, the honeycomb air curtain guide should be removed by :

1. Undoing the screw at each end of the canopy head.
  2. Remove the strip of material from its' steel housing.
  3. Wash this in a mild detergent solution & allow to dry.
- For re-assembly, reverse this process.

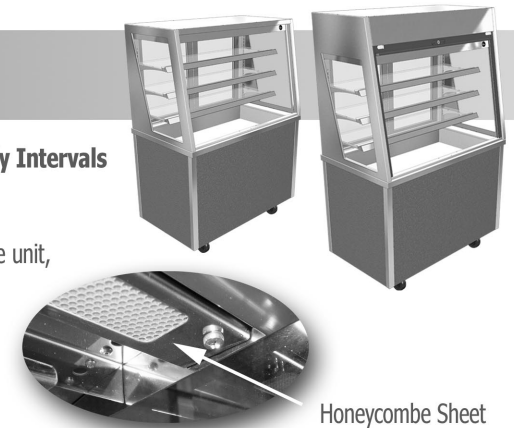

Honeycombe Sheet

### V) Cleaning The Rear Door Air Curtain Guides (Acrylic Panels) - If Doors Fitted

If the display is fitted with rear access doors, the following procedure must be carried out as required :



1. Open the rear access door fully.
2. Lift the acrylic panel upwards & towards yourself, away from frame.
3. The two panels can be split by undoing the allen bolts.
4. The panels should be cleaned using a damp cloth and a mild detergent solution - do not use abrasive pads as this will scratch the surface of the plastic. Dry with a clean cloth before re-assembly.

### W) Cleaning The Automatic Evaporating Drip Tray - 3 Monthly Intervals

The drip tray is hot when on. The display **must be isolated** prior to cleaning and allowed to cool for an hour :



1. Access is by lifting off/ removing the perforated panel of the display. (Take care not to damage mains cable).
2. The drip tray is a stainless steel tank, with a heating element, connected via a connector plug - pull apart the connector plug.
3. Unscrew the thumb-screws to remove the fixing straps and lift out the drip tray and element from its' locating tabs.
4. Discard any water present.
5. Scale deposits on the element can be removed by scraping/abrasive pad. Be careful not to distort the element when cleaning it. Re-assembly is the reverse of the above.



# Glide Cold Well ( & Cold/Deli/Island Gantry Version )

## Operation



### A) Switching On The Glide Cold Well/ Cold Island Well/ Cold Deli

The Glide cold well can be supplied with or without a gantry. If supplied without a gantry, wrapped or bottled product should be displayed.

-  Ensure the mains power supply is switched on. Switch on the display by pressing the **On/ Off** button. The fans and refrigeration will start after 30 seconds.
-  To turn the display lighting on, press the **light** button, a red indicator l.e.d. will light up next to the button. The lighting is housed in a diffuser in the gantry of the display (if fitted).



### B) Viewing The Pre-Set Operating Temperature Of The Display (Set Point)

The display is factory pre-set and maintains produce between 0 °c and 5 °c in a maximum 25 °c ambient temperature, 50% relative humidity. The control has a pre-set operating temp. of 2°c which is suitable for most site situations.

-  To view the set operating temperature: Press and release the blue **set** button, a red indicator light will flash next to the button. The control will display the set operating temp. for 10-12 seconds, then reset to show the current cabinet temperature.



### C) Altering The Pre-Set Operating Temperature Of The Display (Set Point)

Generally, it is **unlikely** that the operating temperature will need to be altered.

-  To alter the pre-set operating temperature: Press and release the blue **set** button, a green indicator light will flash next to the button. The control will display the pre-set operating temperature for 10-12 seconds.

Use the **Up & Down** buttons to adjust the operating temperature.

\* Adjust by 1°c or 2°c only, allow display to operate for one day before further alterations.

-  Press The **Up** button to increase the operating temperature.
-  Press The **Down** button to decrease the operating temperature.

### D) Tamper Proof Locking Of The Control Panel

To prevent tampering, the control can be locked. The current temperature of the display and the pre- set operating temperature can be viewed, but not altered by a customer/ operator.

-  **To Lock The Control Panel :**  
Press and hold both the UP & Down buttons together until the display flashes '**POF**' to indicate the buttons are now locked.

-  **To Unlock The Control Panel :**  
Press and hold both the UP & Down buttons together until the display flashes '**PON**' to indicate the buttons are now unlocked.

### E) What Happens During A Defrost Period ?

The display can run 24 hours a day if required and features pre-set defrost periods. During a defrost period, the display will show '**DEF**' as above.

The condensing unit switches off to allow the cooling coil under the deck to defrost. This process allows any build up of ice around the coil to melt and keeps the cabinet holding temperature correct.

Any ice melting from the coil drains out of the unit and deposits in an evaporation tray, where a heated element turns the water into steam. Movement of air through the condensing unit fan blows this moisture laden air through the grille fitted in the counter. The air is warm and sometimes a 'sizzling' sound can be heard, as defrosted water is being turned to steam.

This is perfectly normal.



Cold Well: No Gantry



Cold Well: Cold Gantry (Reversible Glass)

### F) What The Control Panel LED Symbols Show

A small red light will appear next to each symbol periodically, when the display is in use. The function of these are described below.

#### Defrost Period In Progress -

**DEF** - shown on display - when light flashing, defrost finished & drip time in progress

#### The Cooling Fans Are On -

when flashing, in delay after defrost, will start soon

#### Refrigeration Is On -

when flashing, refrigeration in delay after defrost, will start soon

#### Alarm -

- P1** -Thermostatic Probe Failure
- P2** -Evaporator Probe Failure
- HA** -Maximum Temperature Alarm
- EE** -Data Corruption
- PAL** -Pressure Switch Alarm



**Decimal Point** - for temp. display in °c

If an alarm message shows, please call service department on tel. 01254 238 282

# Glide Cold Well ( & Cold/Deli/Island Gantry Version )

## Operation Continued

### G) Switching Off The Glide Cold Well After Serving Period (In Stand By).

At the end of the serving period, the display should be switched off by pressing the blue **On/ Off** button. The LED will display **'OFF'** for approx. 5 seconds & a red 'stand by' light will switch on above the **On/Off** button.

\* Do not isolate the display by unplugging or turning off at the MCB, unless maintenance is being undertaken. The drip tray operates sometimes when the On/Off button is switched off. Defrost water is present in the automatic evaporating tray and isolating the supply may lead to overflow of the tray.

### H) Recommended Food Display Layout/ Restocking

#### Drinks (Cold Deck Area)

Still & Carbonated, bottled, canned or cartoned, water, dairy, lemonade, wine, beer, lager, fruit juice & health drinks.

#### Food (Cold Deck Area)

Sandwiches, baguettes, rolls, barm cakes, salad, pasta, cheese snacks, cream cakes, pastries, cakes, yoghurt, cereals, fruit in juice & fruit.

#### Deli Gantry Glass Mid-Shelf (If Fitted)

Chocolate, confectionary, crisps, snacks, cakes, drinks (still & carbonated) bottled, canned & cartoned, water, UHT dairy, lemonade, fruit juice & health drinks, fruit, (basket displayed).

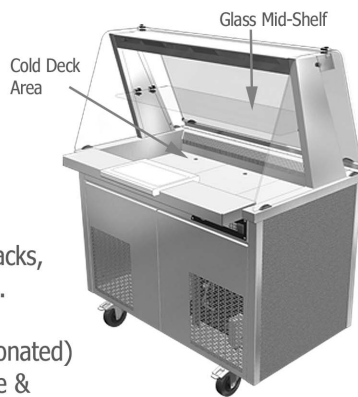

Fig. 1.

#### Product Overcrowding/ Stacking.

This should be avoided at the front and back of the deck area. This may restrict the passage of circulating cold air & increase temperatures (See Example Fig. 1).

### I) Reversing Cold Gantry Glass - Self Help To Assisted Service. (If Fitted).

The display is fitted with 6mm toughened curved top glass. The glass is not designed for objects to be placed on top of it or used as a serve over. Due consideration should be given to overloading/scratching if items are placed on the glass. The glass can be reversed from self help to assisted service position.

#### Removing Or Replacing Top glass.

1. Undo the grub screws on the top of the gantry

1a. This allows the curved top glass to slide forward, to lift out and away from the gantry.



## Maintenance



### Repositioning Top Glass For Assisted Service Use.

2. Stand the flat face of the removed glass (as per stage 1) in the plastic locators at the front of the display (to take the weight).

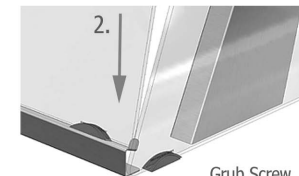

3. Lean the glass towards the gantry so that the curved section rests on the gantry.

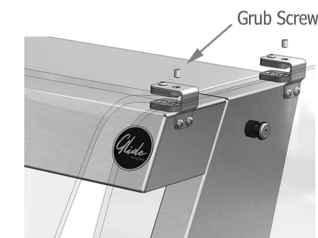

4. The glass can be slid under the front two holding brackets after resting in the locators

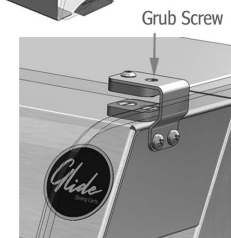

5. Tighten the top grub screws to trap the glass against the front of the gantry nose. Do not overtighten this screw.

### J) Cleaning The Condensing Unit 'Finned Face' - Monthly Intervals

The condensing unit is mounted under the display & chills the coil under the deck. It has a finned coil or 'face' where air is taken into the unit. These fins become choked with dust & airborne particles. The 'finned face' of the condensing unit must be cleaned **monthly** or the efficiency of the display will not be maintained.

**If the operation is neglected, a new condensing unit may be required.**

Before commencing any cleaning or maintenance operation, the display must be isolated from the mains supply by either removing the supply plug from the socket or switching off at the local consumer board (MCB). The following procedure must be used:

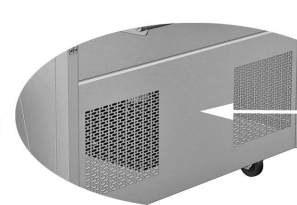

1. Lift off the ventilated metal panel at the front or back.

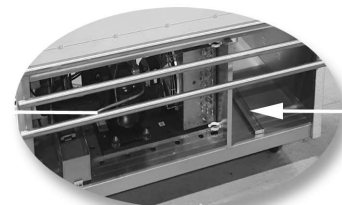

2. This exposes the condensing unit behind.



3. The fins look like the front of a car radiator and attract dust.



4. Clean the fins using a soft brush to loosen the dust and a vacuum to remove the dust.





# Glide Cold Well ( & Cold/Deli/Island Gantry Version )



## Maintenance Continued

### K) Switching Off The Glide Cold Well For Maintenance.

**⚡** Before commencing any cleaning or maintenance operation, the display must be isolated from the mains supply by either removing the supply plug from the socket or switching off at the local isolator ( MCB ).

**N.B. Switching off just using the On/Off button on the control panel does not fully isolate the unit.**

### L) Replacing The LED Light Fitting (If Cold Gantry/Deli Gantry Or Island Gantry Fitted).

Parts replacement must be undertaken by a competent installer. The fitting is mounted in the gantry canopy head. This LED light is a low maintenance light & uses 10-35 % less energy than fluorescent. To replace the light fitting, complete - including the diffuser, the following procedure must be used.



**1.** Disconnect the light lead that is attached to the side of the fitting.



**2.** The complete LED fitting is retained by 2 no. U - shaped clips.



**3.** Prize open one face of the clip and lift the fitting out & down.

Replacement of the LED light fitting is a reverse of the above process. The diffuser cover clips to the LED fitting.

### M) Achieving Best Performance Of The Glide Cold Well.

**1.** Introduce product to the display at or below 5°C

**2.** The display position may effect its' efficiency, beware of :

- \* **High temperatures** in the surrounding room or kitchen.
- \* **Restricted air flow** to the condensing unit below the display. (see section on 'Cleaning The Condensing Unit Finned Face')
- \* **Restricted space to front/behind unit**, (e.g. never block the perforated airflow panels) Unit must have clear space in front of the panel to allow clean air in & heat to escape out..
- \* **Draughts**, common if air conditioning extraction systems are sited above the display.
- \* **Warm air** from nearby heaters, ovens or cooking equipment.
- \* **Radiant energy** i.e. direct sunlight or lamps falling directly onto or into the display.
- \* **Condensation**, can occur if air conditioning systems bring in outside air (not recirculated air) or humidity levels are above 50% around the display.
- \* **Environmental conditions** should always be below 25°C 50% humidity.

Keep Airflow Panels Clear Of Obstruction.



### N) Cleaning The Main Tank ( Below The Display Deck Area )

Routine deep cleaning of the display after product leaks etc. may involve cleaning of the main tank below the removable deck plates. A competent person can carry out this operation : Fully isolate the display, as described in Maintenance section, item K, then decant the unit of produce :



**1.** Lift out the deck plates by the finger holes provided.



**2.** This will expose the fan deck below.



**3.** Remove the screw at each end of the fan deck.



**7.** Lift out the fan deck as shown.

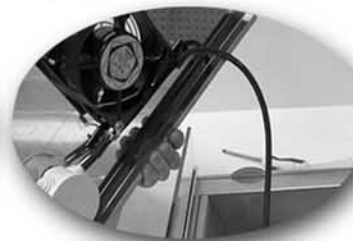

**8.** Stand fan deck to one side, so as not to damage fan cable beneath.



**9.** The tank base & coil cover can be cleaned using a damp cloth & mild detergent.

### O) General Cleaning

Before commencing any cleaning operation, the unit must be isolated. The glass sneeze screen & end glass can be cleaned as required using a proprietary minimum odour glass cleaner. Stainless steel surfaces can be cleaned with a non abrasive cream cleaner or a damp cloth with a mild detergent. The gantry section should be cleaned with a damp cloth only. Never hose down, wash, submerge or rinse electrical parts on the display. The 1/1 GN size deck plates will fit into an industrial dishwasher.

# Glide Cold Well ( & Cold/Deli/Island Gantry Version )



## Maintenance Continued

### P) Replacing The Glide End Glass (If Cold/ Deli/ Island Gantry Fitted).

To replace or remove the end glass from the Glide gantry, the following process is required:

1. Remove the M6 x 35mm connector bolt, shoulder washer & spacer behind, that attach the side glass at the top of the post.
2. Lift the glass up and out from the two side glass locators on the frame. The reverse process is used to replace the end glass.



### Replacing Glide Cold Well Island Gantry Glass (If Fitted).

To replace the island top glass, remove one end glass as described above (Section P Item 1 & 2).

3. Access can be gained to the two glass clamps that hold island top glass in place.
4. Undo all four grub screws that hold the island top glass in position.
5. Remove screws that hold each glass clamp in place, (they are fastened to the side of the gantry post).
6. Slide the glass clamps off the end of the island top glass. The island top glass can be removed from the gantry. Reinstatement is a reverse of this process.

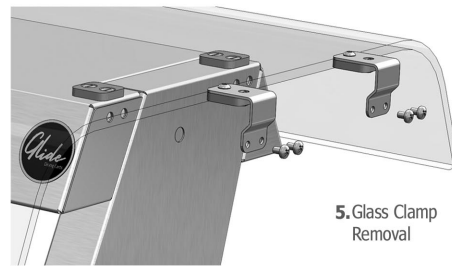

### Q) How To Clean The Cold Air Guide (Honeycomb Sheet Material) - 3 Monthly Intervals

To prevent build up of debris which can eventually clog the honeycomb sheet material helping direct the cold air across the deck area, the following procedure must be used. After isolating the unit :

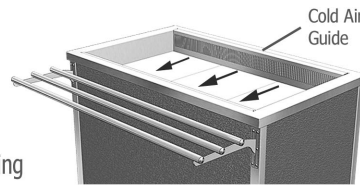

1. Lift out the deck plates by the finger holes provided.



2. Undo screw at each end of the fan deck.

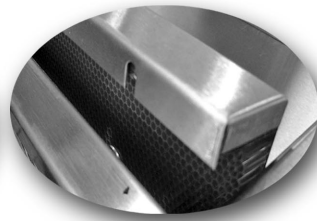

3. Lift the honeycomb air guide upwards, releasing it from the slots.

4. The honeycomb sheet will slide out. Wash this in a mild detergent solution & allow to dry. For re-assembly, reverse this process.

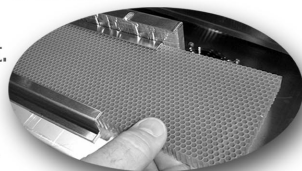

### R) Cleaning The Automatic Evaporating Drip Tray - 3 Monthly Intervals

The drip tray is hot when on. The display **must be isolated** prior to cleaning and allowed to cool for an hour :



1. Access is by lifting off/ removing the perforated panel of the display. (Take care not to damage mains cable).



2. The drip tray is a stainless steel tank, with a heating element, connected via a connector plug - pull apart the connector plug.

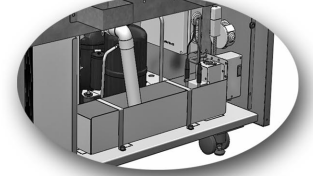

3. Unscrew the thumb-screws to remove the fixing straps and lift out the drip tray and element from its' locating tabs.

4. Discard any water present.

5. Scale deposits on the element can be removed by scraping/abrasive pad. *Be careful not to distort the element when cleaning it.* Re-assembly is the reverse of the above.

### S) Maintaining The Appearance Of The Glide Dining Cart

To help maintain the displays' original appearance, a regular daily cleaning routine should be adhered using the following guidelines.

1. After use, wipe the display with a soft, damp, soapy cloth and rinse with clean water, preferably warm or hot. This action should remove most substances encountered.
2. For more heavy duty substances, including oil, grease and water-borne deposits, the use of a multi purpose cream cleaner applied with a soft, damp cloth will remove the deposits.
3. Where the display has a directionally polished grain, any cleaning with abrasives should be carried out along the direction of the grain to prevent scratching.
4. Always remove wet cleaning aids from the surface after use, to avoid formation of water marks/stains.
5. If required, dry the display after use with a soft dry cloth or towel.
6. The gantry section should be cleaned with a damp cloth only.



# Glide Eutectic Plate Cold Well ( & Cold/Deli/Island Gantry )

## Operation

### A) Operating The Eutectic Plate Cold Well.

The environmentally friendly eutectic plate cold well (no gantry) is part of the Glide range of mobile dining carts.

The eutectic plate cold well features a series of removable, pre-frozen s/steel plates which sit within the base of the display area. The plates contain a cooling gel and provide a contact cooled surface for storage of fruit, bottled drinks or liquid desserts such as yoghurt pots etc.

The display keeps pre-chilled product cold for a typical 2-3 hour lunch period.

This period can be extended by replacing eutectic plates with others (which have also been pre-frozen in advance).

This mobile self contained display is fitted with locking castors to easily position your equipment around your serving space.

When used with the optional ambient gantry, the cupboard is supplied with a 3m lead & 13 amp UK plug (13A 230v 50Hz).

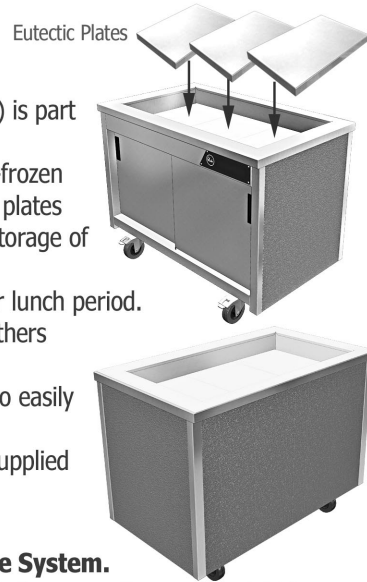

### B) Pre-Chilling Using The S/steel Eutectic Cooling Plate System.

A series of 1/1 Gn size removable s/steel eutectic plates (supplied) are pre-frozen overnight in a freezer. When cold they are placed in the well area. Contact cooling occurs by the transfer of cold energy into the product, which is in contact with the steel surface of the eutectic plate.

#### Well Storage Depth.

Well depth suits 100mm deep 1-1Gn pans (not included) when positioned on top of eutectic plates (Total well depth is 145mm with eutectic plates removed).

### C) Recommended Food Display Types - Eutectic Cold Well Area

The contact cooled surface is ideal for pre-chilled storage of fruit, bottled drinks, fruit juices, cans or liquid desserts such as yoghurt pots etc.

**Deli Gantry Glass Mid-Shelf** (If Fitted). Chocolate, confectionary, crisps, snacks, cakes, drinks (still & carbonated) bottled, canned & cartoned, water, UHT dairy, lemonade, fruit juice & health drinks.

### D) Rear Cupboard Storage Area - Sliding Door Or Shelf Removal.

The Glide eutectic plate cold well features a rear cupboard with removable sliding s/steel doors. Inside are 2 tiers of internal grid shelves for plate/ Gn pan storage. The cupboards accept plates, dishes or up to 10x 1-1 Gn 150mm deep Gn pans (not included) depending on model size.

To remove the sliding cupboard doors or shelves for better cleaning access:



1. Unscrew the pin which is the front sliding door guide.
2. Lift front sliding door upwards & towards yourself.
3. Remove rear door as per stage 2.
4. Wire shelves unhook from box section shelf supports.



### E) Gantry Options

When used with the optional ambient gantrys, the eutectic plate cold well is supplied with a 3m lead & 13 amp UK plug (13A 230v 50Hz). This will be one of the types described below

#### Cold Gantry.

A dual service gantry c/w LED light, reversible curved glass sneeze screen & side glass.

#### Cold Deli Gantry.

Assisted service gantry c/w LED light, glass mid shelf/ full front curved glass & side glass..

#### Cold Island Gantry.

Self help island gantry c/w LED light, double curved glass sneeze screen & side glass.

### F) Operating The LED Gantry Light (If Fitted).

The valance panel features a green illuminated power on/off button.

When depressed the switch illuminates and will turn on the LED light within the gantry above the display.



### G) Reversing Cold Gantry Glass (From Self Help To Assisted Service).

The display is fitted with 6mm toughened curved top glass. The glass is not designed for objects to be placed on top of it or used as a serve over. Due consideration should be given to overloading/ scratching if items are placed on the glass. The glass can be reversed from self help to assisted service position.

#### Removing Or Replacing Top glass.

1. Undo the grub screws on the top of the gantry

1a. This allows the curved top glass to slide forward, to lift out and away from the gantry.



#### Repositioning Top Glass For Assisted Service Use.

2. Stand the flat face of the removed glass in the plastic locators at the display front (to take the weight).

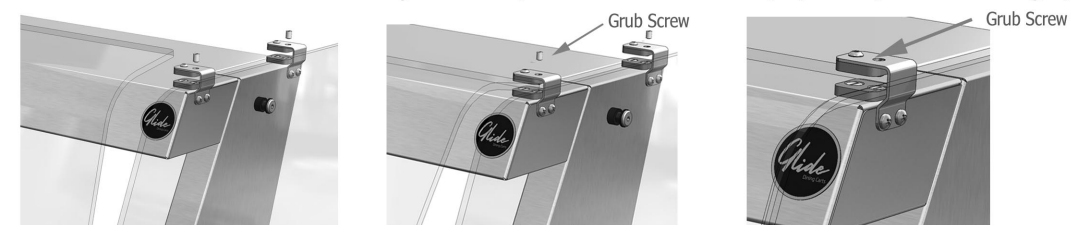

3. Lean the glass towards the gantry so that the curved section rests on the gantry.

4. The glass can be slid under the front two holding brackets after resting in the locators

5. Tighten the top grub screws to trap the glass against the gantry front.

# Glide Eutectic Plate Cold Well ( & Cold/Deli/Island Gantry )



## Maintenance

### H) Switching Off The Glide Eutectic Plate Cold Well For Maintenance (If Gantry Fitted).

If fitted with a gantry, then before commencing any cleaning or maintenance operation, the display must be isolated from the mains supply by either removing the supply plug from the socket or switching off at the local MCB.

### I) Replacing The LED Light Fitting (If Cold Gantry/Deli Gantry Or Island Gantry Fitted).

Parts replacement must be undertaken by a competent installer. The fitting is mounted in the gantry canopy head. This LED light is a low maintenance light & uses 10-35 % less energy than fluorescent. To replace the light fitting, complete - including the diffuser, the following procedure must be used.

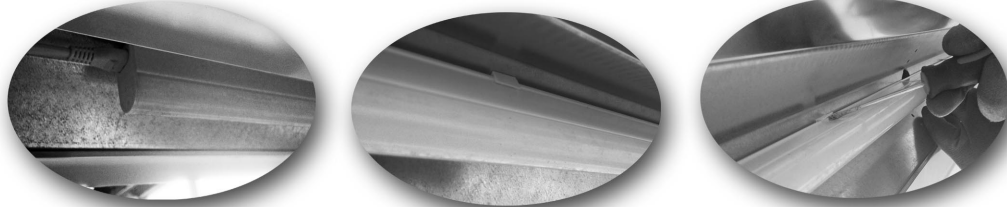

1. Disconnect the light lead that is attached to the side of the fitting.

2. The complete LED fitting is retained by 2 no. U - shaped clips.

3. Prize open one face of the clip and lift the fitting out & down.

Replacement of the LED light fitting is a reverse of the above process. The diffuser cover clips to the LED fitting.

### J) Achieving Best Performance Of The Glide Eutectic Plate Cold Well.

1. Introduce product to the display at or below 5°C

2. The display position may affect its' efficiency, beware of :

- \* **High temperatures** in the surrounding room or kitchen.
- \* **Draughts**, common if air conditioning extraction systems are sited above the display.
- \* **Warm air** from nearby heaters, ovens or cooking equipment.
- \* **Radiant energy** i.e. direct sunlight or lamps falling directly onto or into the display.

3. **Eutectic Plates** - pre-frozen overnight in a freezer - should always be used in the well area to provide a contact cooled surface.

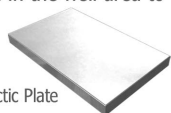

Eutectic Plate

The plates transfer cold energy into the product standing on their surface. This medium works best with liquid based products. The serving period can be extended by replacing them with additional pre-frozen plates.

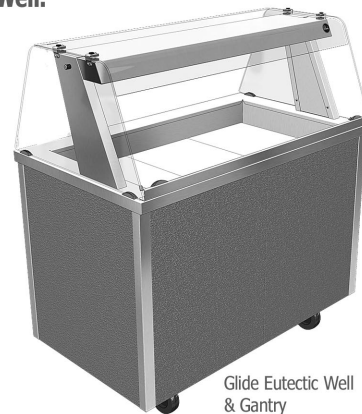

Glide Eutectic Well & Gantry

### K) Replacing The Glide End Glass (If Cold/ Deli/ Island Gantry Fitted).

To replace or remove the end glass from the Glide gantry, the following process is required:

1. Remove the M6 x 35mm connector bolt, shoulder washer & spacer behind, that attach the side glass at the top of the post.
2. Lift the glass up and out from the two side glass locators on the frame. The reverse process is used to replace the end glass.



1. Bolt Removal

### Replacing Glide Eutectic Well Island Gantry Glass (If Fitted).

To replace the island top glass, remove one end glass as described above (Section K Item 1 & 2).

3. Access can be gained to the two glass clamps that hold island top glass in place.
4. Undo all four grub screws that hold the island top glass in position.
5. Remove screws that hold each glass clamp in place, (they are fastened to the side of the gantry post).
6. Slide the glass clamps off the end of the island top glass. The island top glass can be removed from the gantry. *Reinstatement is a reverse of this process.*

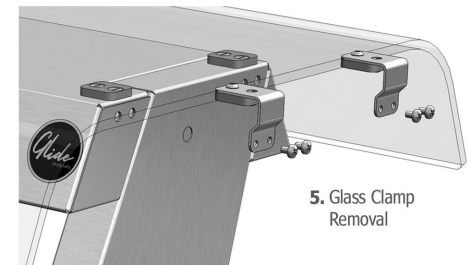

5. Glass Clamp Removal

### L) Maintaining The Appearance Of The Glide Dining Cart

To help maintain the displays' original appearance, a regular daily cleaning routine should be adhered to using the following guidelines:

1. After use, wipe the display with a soft, damp, soapy cloth and rinse with clean water, preferably warm or hot. This action should remove most substances encountered.
2. For more heavy duty substances, including oil, grease and water-borne deposits, the use of a multi purpose cream cleaner applied with a soft, damp cloth will remove the deposits.
3. Where the display has a directionally polished grain, any cleaning with abrasives should be carried out along the direction of the grain to prevent scratching.
4. Always remove wet cleaning aids from the surface after use, to avoid formation of water marks/stains.
5. If required, dry the display after use with a soft dry cloth or towel.
6. The gantry section should be cleaned with a damp cloth only.



Deli Gantry

Cold Gantry



Island Gantry



CATERING EQUIPMENT DESIGN



# Troubleshooting Guide - Glide Cold Refrigerated Displays



## Problem

## Possible Cause

## Solutions

### No power.

1. Is power switched on ?
2. Is the unit switched off at the valance mounted control panel ?
3. Is operator / cleaning staff switching unit off at counter MCB or a wall socket ?
4. End User / Installer to check the fuse in the 13 amp plug top
5. Is the electrical supply size serving the display incorrectly fitted by installer

1. End User to maintain
2. End User to rectify ( operational issue )
3. End User to rectify ( operational issue )
4. End User / Installer to maintain
5. End User / Installer to rectify

### Not working / control panel showing HA

1. Is the condensing unit face ( finned face ) clear of dust/ debris
2. Is room temperature above the equipments operating level ( > 25°C )
3. Is humidity level in atmosphere above the equipments operating level ( > 50% RH )
4. Are the perforated airflow panels to condensing unit blocked by an obstacle e.g. bin/ boxes etc. ?

1. End User to maintain or qualified service engineer to repair if not chilling after cleaning.
2. End User / Installer to reduce room temperature
3. End User / Installer to reduce humidity level
4. End User to remove obstruction

### Other messages shown on control panel.

1. Controller showing **DEF** - unit in its defrost period
2. Controller showing **P1** - thermostatic probe failed
3. Controller showing **P2** - evaporator probe failed
4. Controller showing **PAL** - pressure switch alarm
5. Controller showing **EE** - programme error

1. No action - Unit will return to normal operating shortly
2. CED service engineer to replace digital probe behind air off grille.
3. CED service engineer to replace digital probe behind evaporator coil
4. Turn unit off & on at control panel / CED service engineer to replace pressure switch
5. CED service engineer to attend site.(replace control panel fascia or control box)

### Not chilling.

1. Has operator increased set point of the cabinet from factory pre-set of 2°C ? ( to check - press control panel 'set' button )
2. Is air conditioning causing a draught which is causing probe to show high temperatures ? ( to check - hold napkin loosely above display )
3. Are draughts affecting the display performance & causing probe to show high temperatures ? ( to check - shut adjacent doors, check corridor draughts )
4. Is food being introduced pre-chilled ? ( ambient food increases the cabinet temp.until it chills )
5. Is there hot air spillage from adjacent equipment ( combi oven, baked potato oven etc. ) ?
6. Is food being displayed tightly packed, ( probe shows high temps. - airflow restricted around it )
7. If Glide cold well/ deli - Are the food containers too tall ( more than 100mm high ) ? ( if more than 100mm tall, some of food will be held outside of the chilled zone )
8. Are bottles being displayed multiple stacked ? ( probe shows high temps./airflow restricted )
9. Is direct sunlight or spotlights shining directly onto or into the display ?
10. Can the condensing unit be heard working underneath the display ?
11. Are the fans working under deck plates ?
12. Engineer On site - Condensing unit solenoid valve may be faulty / may need adjusting
13. Engineer On site - Refrigeration gas leak/ insufficient gas

1. Operator to adjust.
2. End User / Installer to rectify / redirect site condition
3. End User / Installer to rectify site condition
4. End User to rectify their site operation / food supply chain
5. End User to rectify their equipment layout on site.
6. End User to rectify their food display layout (see user manual)
7. End User to rectify incorrect display containers/ dishes
8. End User to rectify their food display layout (see user manual)
9. End User / Installer to rectify site condition
10. CED service engineer to attend - component fault, incorrect maintenance.
11. CED service engineer to repair / replace on site.
12. CED service engineer to adjust / replace condensing unit solenoid valve
13. CED service engineer to repair leak / replenish gas



Cold Well (No Gantry)



Cold Deli

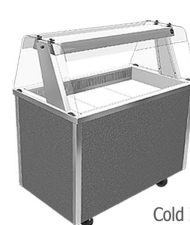

Cold Island Well

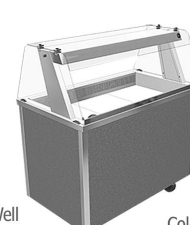

Cold Well

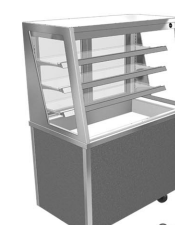

Cold Multideck



# Troubleshooting Guide - Glide Cold Refrigerated Displays Continued



## Problem

## Possible Cause

## Solutions

### Gantry Light Not Working.

1. Has operator switched unit / gantry light on at the control panel ?
2. Has switch on side of the LED gantry light fitting been switched off ? (During cleaning)
3. Faulty LED light fitting - replace complete fitting

1. End User to resolve (see user manual)
2. End User to resolve (flick switch on side of fitting)
3. Competent End User or CED qualified service engineer to fit on site.

### Leaking/ Overflowing Evap Tray.

1. Is operator switching unit off at MCB or wall socket ? (to check - switch off at control panel only)
2. Is room temperature above the equipments operating level ( > 25°C )
3. Is humidity level in atmosphere above the equipments operating level ( > 50% RH )
4. Is the heating element in evaporation tray underneath working (if water scale deposits have affected the heating element performance in evap tray)
5. Is the heating element glowing hot / no water present in tray (element failure)

1. End User / Installer to rectify - should stop leaking if switched off at control panel (stand by)
2. End User / Installer to reduce room temperature
3. End User / Installer to reduce humidity level
4. End User / CED service engineer replace evap tray complete
5. End User / CED service engineer replace evap tray complete

### Glass Misting Up/ Condensation On Front Glass. (Glide Multideck Assisted Service)

1. Is unit in defrost mode?
2. Is room temperature above the equipments operating level ( > 25°C )
3. Is humidity level in atmosphere above the equipments operating level ( > 50% RH )
4. Does the comfort heater fitted under front glass feel warm ?
5. Has operator accidentally decreased set point (operating temperature) of the cabinet from 2°C (to check - press control panel set button)

1. No action required - unit will self rectify.
2. End User / Installer to reduce room temperature
3. End User / Installer to reduce humidity level
4. CED service engineer replace heater / check wiring or fuse on site
5. End User / Installer to adjust



Cold Well

### Cannot Alter Parameters On Control Panel.

1. Is the control panel locked ?

1. End User to resolve ( press and hold up & down arrows until display flashes PON )

### Rear Doors Not Shutting Properly / Catching On Gasket

1. Has the unit been damaged during transport/ installation ? ( In twist )
2. Shelves not fitted correctly by installer - narrowest shelf is bottom shelf
3. Have the removable acrylic air guide panels to doors not been re-fitted correctly by the operator ?
4. Is produce on lower shelf obstructing stainless steel flange on acrylic door panel ?

1. Inform your Distributor / Installer on arrival of equipment.
2. End User / Installer to rectify incorrect shelf fitting on site
3. End User / Installer to rectify incorrect fitting on site
4. End User / Installer to redistribute produce.

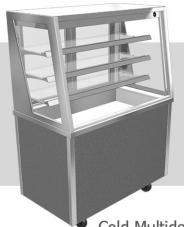

Cold Multideck

### Noise / Heat / Steam / Smells From Rear Of Unit.

1. Sizzling noise - normal ( defrost water evaporating on heating element in tray underneath )
2. Heat / steam output through vent panels - normal ( condensing unit heat being extracted )
3. Rattling to rear - evaporation tray has become loose ( dislodged by end user )
4. Burning smell - normal ( new heating element in tray underneath 'bedding in' )
5. Sour / rotten smell - Has milk/ oil/ liquid been spilt into the deck area ?  
ELECTRICAL SHOCK DANGER - Isolate unit immediately.
6. Sweetish smelling gas - Refrigerant smell - possible refrigerant leak  
\*\* only applicable to R290 hydrocarbon type chilled range of displays.

1. No action required
2. No action required
3. End User / Installer to re-seat evaporation tray into base holding tabs & re-fit retaining strap.
4. No action required
5. CED qualified service engineer to isolate & deep clean tank/ coil area/ bottle trap waste and evaporation tray.
6. Switch the unit off at the control panel - DO NOT ISOLATE AT MAINS SUPPLY  
R290 qualified / CED service engineer to repair.  
In the event of evacuation of the area or injury due to a potential refrigerant leak, refer to site specific HSE instructions.



Cold Well (No Gantry)



### Glide Electrical Socket Connections.

Most Glide mobile units are operated by 13A plug top connected to a dedicated single socket outlet (SSO) (13A), unless its' power supply exceeds 13A. *If connected to a double socket outlet, care must be taken not to exceed the circuit capacity.*

**Glide Electrical Trailing Lead Protection.** CED recommend the use of proprietary cable covers to protect overground trailing leads, reduce trip hazards, limit accidental electrical partial plug disconnection and to keep wire safe from impact damage, as damaged cable wire can cause an electrical fault. HSE GOV.UK Guidance On Managing Temporary Electrical Installations Re: Cabling advises: "Route cables to minimise tripping hazards or potential mechanical damage...Give particular care to the position of cable connections. You can also use **cable ramps** or similar to protect cables running overground across route ways to help avoid them becoming tripping hazards".



Proprietary Cable Cover.



Cold Deli

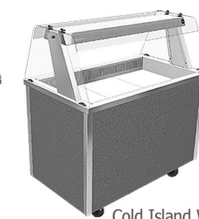

Cold Island Well



# Glide Ceran Top Hot Cupboard (& Hot/Island Hot Gantry Versions)



## Operation

### Ceran Top Hot Cupboard (No Gantry)

### Ceran Top Hot Cupboard & Hot Gantry



Glide ceran top hotcupboard (no gantry) & the hot gantry versions are designed for the temporary storage of pre-cooked food whilst service is in progress, as well as preheating plates & dishes.

**Hot Cupboard.** The cupboard is heated via a fan assisted heating element and is fitted with removable sliding doors and removable, adjustable height chrome grid shelves, in manageable sections for easy cleaning. The cupboard holding temperature is adjustable by thermostat & is dependent on the food type, amount of food in container, etc. (It is important to always keep sliding hotcupboard doors closed when unit is heating).

**Ceran Top.** The Glide ceran top keeps pre-cooked food at serving temperature. It is suitable for display of most types of hot foods in flat bottom dishes, allowing best heat transfer. (Cast iron dishes are not suitable). The self-regulated surface temperature is controlled at around 90° by neon on/off switch. (These units are not designed to heat up cold food).

**Hot Gantry.** The hot gantry is controlled by neon on/off switch & provides infra red top heat to the surface of the food on display. The heat lamps in the gantry are a 'jacketed' safety bulb. The reversible toughened glass gantry can be positioned for self help or assisted service operation. (Factory set as self help sneeze screen).

**Ceran Top Hot Cupboard (No Gantry).** For best performance always use lids on Gn containers when not serving & stir food in containers regularly.

### A) Switching On The Glide Ceran Top Hot Cupboard (No Gantry) & Hot Gantry Version.

**Mains Power On-Off.** (Green Illuminating On/Off Switch)  
The mains power supply is controlled by the green on/off switch. Ensure the display is plugged in to the supply socket and the socket is switched on. The switch will illuminate when on.

**Ceran Top On-Off.** (Red Illuminating On/Off Switch)  
Ensure mains power is switched on prior. The ceran top supply is controlled by the red on/off switch. The switch will illuminate when on.

**Hot Gantry - If Fitted** (Yellow On/Off Switch)  
To turn the quartz heat lighting on above the ceran surface, use the yellow on/off switch. The quartz heat lighting is housed in the gantry above the display and will heat the surface of the food. Stir food regularly to distribute the top heat within. The switch will illuminate when on.



### Hot Cupboard Adjustment. (Thermostatic Control Knob)

The hotcupboard is switched on using the thermostatic control knob. Turning the knob clockwise increases the temperature. This will turn on the fan assisted heating element. Depending on the size of the unit, the heat up time may vary. For plate warming adjust to above a 40 degrees C setting, for temporary storage of food always set above 85 degrees C (if being presented on the ceran top imminently). The general hot cupboard temperature shown is an average indication, as storage within the cupboard changes the airflow direction. (Nominal temperature adjustment can be made from the control knob). **The cupboard is supplied with a 3m lead & 13amp UK plug (13A 230v 50Hz)**

### B) Optional Spiked Carving Adaptor - 1/1Gn (Hot Gantry Option Only).

The sit-on spiked carving lid & 20mm(d)1-1 Gn juice collection tray under. are supplied in a s/steel surround frame with rubber feet. The unit sits in the front/ back edges of ceran worktop frame. A shallow amount of water can be added into juice collection tray under, to assist in moisture retention/ enable easier cleaning after serving.

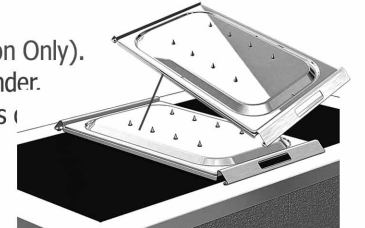

### C) Reversing Hot Gantry Glass - Self Help To Assisted Service. (If Fitted).

The display is fitted with 6mm toughened curved top glass. The glass is not designed for objects to be placed on top of it or used as a serve over. Due consideration should be given to overloading/scratching if items are placed on the glass. The glass can be reversed from self help to assisted service position.

#### Removing Or Replacing Top glass.

1. Undo the grub screws on the top of the gantry
- 1a. This allows the curved top glass to slide forward, to lift out and away from the gantry.

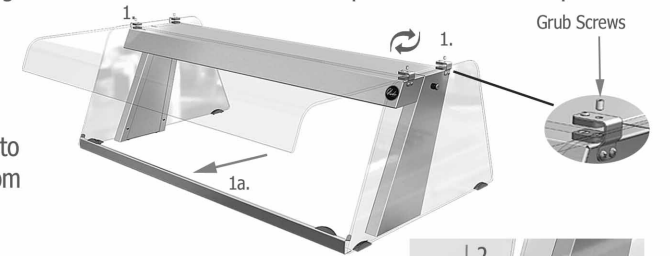

#### Repositioning Top Glass For Assisted Service Use.

2. Stand the flat face of the removed glass (as per stage 1) in the plastic locators at the front of the display (to take the weight).



3. Lean the glass towards the gantry so that the curved section rests on the gantry.

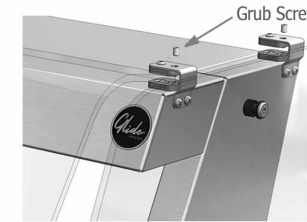

4. The glass can be slid under the front two holding brackets after resting in the locators

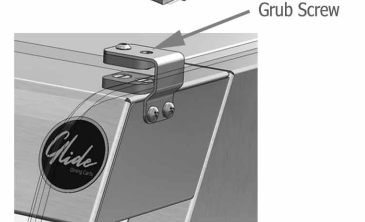
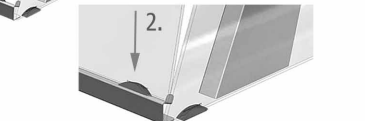

5. Tighten the top grub screws to trap the glass against the front of the gantry nose. Do not overtighten this screw.

# Glide Ceran Top Hot Cupboard (& Hot/Island Hot Gantry Versions)



## Operation Continued

### D) Switching Off The Glide Ceran Top Hot Cupboard After Serving.

At the end of the serving period, the Glide ceran top hotcupboard should be switched off using the rocker switches/dial on the control panel.

- Hot gantry (yellow switch).
- Ceran Top (red switch).
- Hot Cupbd. (turn dial to '0').
- Main power (green switch).



### E) Best Practice For Using Glide Ceran Top Hot Cupboard.

- 1) The unit should only be turned on 45 mins. prior to merchandising.
- 2) Only switch gantry lights on (if fitted) just prior to merchandising.
- 3) Set the hot cupboard dial to the required serving temp. (70-75 deg C) when turning unit on.
- 4) Dishes should be placed on the heated glass surface, not on the frame of the ceran top.
- 5) Product should be displayed in flat base containers or dishes, ensuring the dish base is in full contact with the hotplate surface.
- 6) If the unit has **no hot gantry** fitted, all food containers must be used with a lid.
- 7) Product should be stirred regularly to ensure heat distribution within the food.
- 8) Cast iron dishes are not suitable.
- 9) Pre cooked food should be introduced at or above the required serving temperature.
- 10) Do not site the cabinet in a location where draughts can enter the heated display space.
- 11) The ambient room temperature must be above 18 degrees C before operating the cabinet.
- 12) Place dishes on the ceran surface, do not slide them on, this can leave scratches in the glass.

### (Ceran Top) Recommended Food Types

#### Breakfast

*Long Term Holding (lunch period)*  
Baked beans, tomatoes, bacon, sausage, black pudding, mushrooms, hash browns

#### Lunch/Dinner

*Long Term Holding (lunch period)*  
Stews, curry, chilli dishes, sliced meats in gravy or sauce, vegetables (dry or in liquid), ribs with sauce, chicken portions

#### Breakfast/Brunch

*Short Term Holding (15-20 minutes)*  
Omlettes, fried/ boiled eggs, baked potatoes

#### Lunch/Dinner

*Short Term Holding (15-20 minutes)*  
Battered fish, chips/ fries



### F) (Hot Gantry) Operational Use Of The Quartz Heat Lamps

The 200w jacketed lamps heat up rapidly and are extremely hot, never touch the lamps when they are switched on. **Do not touch the lamps with bare fingers as oil deposits from the skin can cause the lamp to fail.** The glass outer sleeve protects the filament from falling into food if the fitting fails.

## Maintenance

### G) Replacing The Glide End Glass (If Hot Gantry Fitted).

To replace or remove the end glass from the Glide hot gantry, the following process is required:

1. Remove the M6 x 35mm connector bolt, shoulder washer & spacer behind that attach the side glass at the top of the post.
2. Lift the glass up and out from the two side glass locators on the frame. The reverse process is used to replace the end glass.



### Replacing Glide Island Hot Gantry Glass (If Fitted).

To replace the island top glass, remove one end glass as described above (Section G Item 1 & 2).

3. Access can be gained to the two glass clamps that hold island top glass in place.
4. Undo all four grub screws that hold the island top glass in position.
5. Remove screws that hold each glass clamp in place, (they are fastened to the side of the gantry post).
6. Slide the glass clamps off the end of the island top glass. The island top glass can be removed from the gantry. Reinstatement is a reverse of this process.

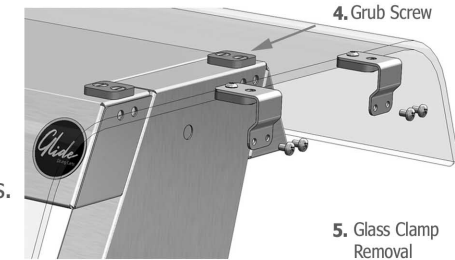

### H) Switching Off The Ceran Top Hot Cupboard For Maintenance.

Before commencing any cleaning or maintenance operation, the display must be isolated from the mains supply by removing the supply plug from the socket.

### I) Maintaining/Replacing The Quartz Heat Lamps

The life of the lamps will be extended if they are cleaned weekly when cold, using methylated spirits & a cotton pad. Do not touch the lamps with bare fingers as oil deposits from the skin can cause the lamp to fail. The lamps are mounted in the gantry canopy head. When replacing the lamp, ensure the display is isolated and replace the lamp, ensuring no skin contact is made with the fitting during the operation.



**I.** Lamp replacement avoiding skin contact with the fitting

Lamps used are 'jacketed' 200 watt quartz infrared bulbs, not tungsten bulbs used in domestic lighting.



# Glide Ceran Top Hot Cupboard (& Hot/Island Hot Gantry Versions)



## Maintenance Continued

### J) Cleaning The Hot Cupboard Area (After Isolation From Electrical Supply).

The base of the hotcupboard contains the fan assisted heating element, within a protective steel cover. Above the heating unit are two heavy duty shelves which are adjustable in height.

**Removing/ Adjusting The Shelves.** Each shelf consist of two removable lengths of steel box section, supported each end by a bracket which clips into the wall of the cupboard base. Across each piece of steel box section are a series of wired chrome grid shelves, they hook over the box section shelf support and are suitably sized for easy removal. Once these are lifted out it is possible to lift out the box section shelf supports to give access to the cupboard base. Deep cleaning can then be undertaken. Never hose down, wash, submerge or rinse electrical parts on the display.

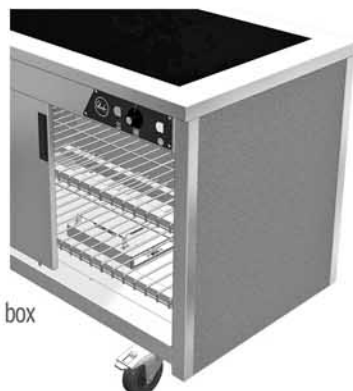

**Removing Hot Cupboard Doors.** To aid access for cleaning of the cupboard area, remove the sliding doors:



1. Remove the outer door guide pin by unscrewing and set this aside (to refit later).

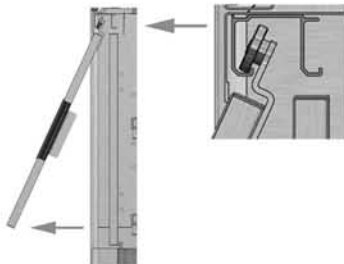

2. Tilt the outer door forwards and lift it slightly to release it from the door guide track. Do the same with the inner door to remove. (Reverse the process to refit, re-fit the outer door guide pin last).



### K) Power Supply Failure To The Display

In the event that the unit will not switch on e.g. none of the neon on/ off switches illuminate, check and replace the plug top fuse, ensure the same rated fuse is replaced. If this does not resolve the problem, call your equipment provider.



### L) Cleaning/ Care Of The Ceran Glass Top Surface



After use switch off, isolate from the electrical supply and allow to cool. The surface should be cleaned using a proprietary glass/ceramic hotplate cleaner & nylon scourer or proprietary hob scraper, normally available from your installer or a kitchen appliance retailer. Wire wool, Scotchbrite and similar abrasives must not be used. The hotplate sections should be cleaned after every service period, otherwise deposits of burnt on food waste may build up and damage may be caused in attempting to remove them. This should be carried out when the hotplate is still warm after use. **Scratches can be caused by the underside of ceramic dishes on the glass. This can be minimised by placing dishes on the surface, not sliding.**

### M) General Cleaning Of The Glide Ceran Top Hot Cupboard

Before commencing any cleaning operation, the unit must be isolated. The glass sneeze screen (if fitted) can be cleaned as required using a proprietary minimum odour glass cleaner. Stainless steel surfaces can be cleaned with a non abrasive cream cleaner or a damp cloth with a mild detergent. Never hose down, wash, submerge or rinse electrical parts on the display.



### N) Maintaining The Appearance Of The Glide Ceran Top Hot Cupboard

To help maintain the displays' original appearance, a regular daily cleaning routine should be adhered using the following guidelines.

1. After use, wipe the display with a soft, damp, soapy cloth and rinse with clean water, preferably warm or hot. This action should remove most substances encountered.
2. For more heavy duty substances, including oil, grease and water-borne deposits, the use of a multi purpose cream cleaner applied with a soft, damp cloth will remove the deposits.
3. Where the display has a directionally polished grain, any cleaning with abrasives should be carried out along the direction of the grain to prevent scratching.
4. Always remove wet cleaning aids from the surface after use, to avoid formation of water marks/stains.
5. If required, dry the display after use with a soft dry cloth or towel.
6. The gantry section should be cleaned with a damp cloth only.





# Troubleshooting Guide - Glide Ceran Top Hot Cupbd. (& Hot Gantry Option)



## Problem

## Possible Cause

## Solutions

**Ceran Top Hot Cupboard - No Power/ No Illuminated Rocker Switches On.**

1. Is green illuminated 'power on' switch switched on ?
2. Is the hot gantry, hot cupboard heating or ceran top heating turned on at the control panel ?
3. Is operator / cleaning staff switching unit off at counter MCB or a wall socket ?
4. End User / Installer to check the fuse in the 13 amp plug top.
5. Has fuse tripped in incoming power circuit breaker supply or is the RCD turned off ?
6. Is red illuminated 'ceran' switch switched on ? Is it illuminated when on ?
7. Is yellow illuminated 'hot gantry' switch switched on ? Is it illuminated when on ?

1. End User to maintain
2. End User to rectify ( operational issue )
3. End User to rectify ( operational issue )
4. End User / Installer to maintain
5. End User to replace suitably sized fuse.
6. CED service engineer to replace switch/ heater mat/ ceran section.
7. End User to replace lamp /CED service engineer to repair

**Ceran Top Not Maintaining Food Temperature.**

1. (No Gantry Model Only) Are lids being used with the presentation dishes ?
2. Are heated quartz lamps all working.
3. Are all heating zones on the base of the unit hot ?
4. Are too many dishes being presented on the surface at once (i.e. not within ceran surface on base)
5. Are flat bottom ceramic type dishes being used (rimmed dishes prevent hotplate surface contact)
6. Is produce being introduced at correct temperature to hotplate (food supply chain issue)
7. Is too much produce being held in containers (food should be displayed level with container top)
8. Is a ceiling mounted air conditioning draft present over display (Hold napkin over display to test)
9. Are drafts present from open entrance doors/ windows/ corridors (Hold napkin over display to test)

1. End User to provide lids to limit heat loss from containers.
2. End User / Installer to replace 200w jacketed quartz infra red halogen lamps.
3. CED service engineer to replace heater mat/ ceran section.
4. End User to display food dishes within heated zone area , not around perimeter of base.
5. End User to use correct dishes ( as preventing base heat reaching the food core )
6. End User to rectify. ( food supply chain issue )
7. End User to rectify ( operational issue )
8. End User to re-direct/ switch off/ re-site air conditioning.
9. End User to eliminate draft over display surface.

**Hot Cupboard Not Maintaining Food Temperature.**

1. Has the thermostat control knob position been altered/ turned down ?
2. Are the sliding/ hinged hot cupboard doors being left open ?
3. Is the food being introduced above the required serving temperature ?
4. Has the hot cupboard been pre-heated before introduction of pre-cooked food/ plates. ?
5. Is short term storage of food in the cupboard area imminent prior to display ?
6. Are there only a few food containers within ?

1. End User to adjust thermostat control knob to max. on control panel.
2. Heat loss and temperature recovery time should be allowed for after closing doors.
3. The hot cupboard is designed to maintain pre-cooked food at serving temperature. It is not designed to heat food from cold.
4. A suitable warm up period is required before use of the hot storage areas.
5. Food should be presented onto the ceran top/ hot gantry as soon as practical to benefit from both base and top heat.
6. Move the containers to the lower shelf, closer to the heater element.

## Model Description.

Glide mobile dining cart, ceran glass hotplate top (no gantry), electric, 700(d) x 900(h), accommodates 1-1 Gn flat btm. dishes/lids (not included), fan assisted hotcupboard under with removable s/steel sliding doors & 2 tiers of adjustable/ removable internal grid shelves for plate/ Gn container holding. Front/side base panels in leathergrain plastisol steel, colour merlin grey (BS 18B25), lockable castors, control panel to operator side, 3m lead. Hot cupboard has thermostatic control, ceran top & mains power are controlled by neon on/off switches. Gantry options are also controlled by neon on/off switch. Electrical supply (no gantry/+ hot gantry) = 230V 50Hz 13A UK plug top. (Gantry/ Tray Rails Optional)

\*For best performance (no gantry model) always use lids on Gn containers when not serving, stir food in containers regularly\*

Code	Description	Capacity (Gn)	Dimensions (L x D x H mm)	Depth With Tray Slide Up/ Down	Weight (kg)	Total Power (kW)	
						No Gantry	+ Hot Gantry
GHP2	Glide Ceran Top Hot.Cupd No Gantry	2-1	825 x 700 x 900	1000/ 740mm	49	2.19	2.56
GHP3	Glide Ceran Top Hot.Cupd No Gantry	3-1	1175 x 700 x 900	1000/ 740mm	69	2.37	2.97
GHP4	Glide Ceran Top Hot.Cupd No Gantry	4-1	1525 x 700 x 900	1000/ 740mm	92	2.55	2.95
GHP5	Glide Ceran Top Hot.Cupd No Gantry	5-1	1875 x 700 x 900	1000/ 740mm	114	2.73	2.83



Ceran Top H C (No Gantry)



Ceran Top H C (Hot Gantry)



Ceran Top H C (Island Hot Gantry)

# Glide Plain Top Hot Cupboard (No Gantry/ Hot /Ambient Gantry)

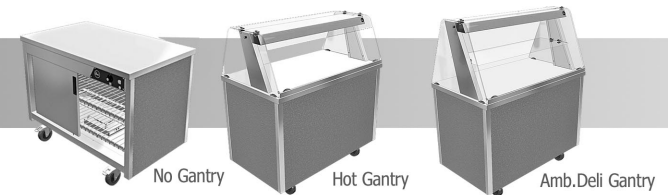

## Operation

### Plain Top Hot Cupboard (No Gantry)



H Cupb. Adjust Power On-Off

### Plain Top Hot Cupboard & Gantry



H Cupb. Adjust Gantry On-Off Power On-Off

**Use.** Glide plain top hotcupboard (no gantry) & the gantry versions are designed for preheating food, plates & dishes. With a hot gantry added the task lighting provides those vital last seconds of top heat at food pick up points, in the transfer of plated meals from kitchen to table. By adding either LED light gantries or assisted service deli gantry with glass shelf, the cupboard top can be used for plate, cutlery, condiments or snack selection.

**Plain Top Hot Cupboard.** The plain s/steel cupboard top provides vital storage space during the lunch period. The hot cupboard below is heated via a fan assisted heating element and is fitted with removable sliding doors and adjustable height chrome grid shelves, in manageable sections for easy cleaning. The cupboard holding temperature is adjustable by thermostat & is dependent on the food type, amount of food in container, etc. (It is important to always keep sliding hotcupboard doors closed when unit is heating).

**Ambient LED Gantry/Deli LED Gantry/ Island LED Gantry.** If supplied, the ambient gantry, island ambient gantry or assisted service deli gantry are all fitted with 4000 kelvin LED lighting & are controlled by an illuminating neon on/off switch.

**Hot Gantry.** If supplied, the hot gantry is also controlled by a neon on/off switch & provides infra red top heat to the surface of the food on display. The heat lamps in the gantry are a 'jacketed' safety bulb. The reversible toughened glass hot gantry & ambient LED gantry can be positioned for self help or assisted service operation. (Factory set as self help sneeze screen).

### A) Switching On The Glide Plain Top Hot Cupboard (No Gantry) & Gantry Version.

**Mains Power On-Off.** (Green Illuminating On/Off Switch)  
The mains power supply is controlled by the green on/off switch. Ensure the display is plugged in to the supply socket and the socket is switched on. The switch will illuminate when on.

**Hot Or Ambient LED Gantry - If Fitted** (Yellow On/Off Switch)  
To turn the quartz heat or LED lighting on above the steel surface, use the yellow on/off switch. The quartz heat lighting is housed in the gantry above the display and will temporarily heat the surface of the food held below. Stir food regularly to distribute the top heat within. The switch will illuminate when on. The LED gantry has a protective light cover on the fitting to prevent entry into food below if damaged.

**Hot Cupboard Adjustment.** (Thermostatic Control Knob)  
The hotcupboard is switched on using the thermostatic control knob. Turning the knob clockwise increases the temperature. This will turn on the fan assisted heating element. Depending on the size of the unit, the heat up time may vary. For plate warming adjust to above a 40 degrees C setting, for temporary storage of food always set above 85 degrees C (if being presented on the ceran top imminently). The general hot cupboard temperature shown is an average indication, as storage within the cupboard changes the airflow direction. (Nominal temperature adjustment can be made from the control knob). **The cupboard is supplied with a 3m lead & 13amp UK plug (13A 230v 50Hz)**

**B) Gantry Option Types (If Fitted).**  
**Heated Gantry.** Heated gantry option provides short term hot holding of plated meals under.  
**Ambient/ Island Or Deli Gantry.** LED reversible glass gantry or island gantry options can be added to increase food presentation space. The deli gantry option also includes a glass mid-shelf.

**C) Reversing Hot/Ambient LED Gantry Glass - Self Help To Assisted Service.** (If Fitted).  
The display is fitted with 6mm toughened curved top glass. The glass is not designed for objects to be placed on top of it or used as a serve over. Due consideration should be given to overloading/scratching if items are placed on the glass. The glass can be reversed from self help to assisted service position.

#### Removing Or Replacing Top glass.

1. Undo the grub screws on the top of the gantry
- 1a. This allows the curved top glass to slide forward, to lift out and away from the gantry.

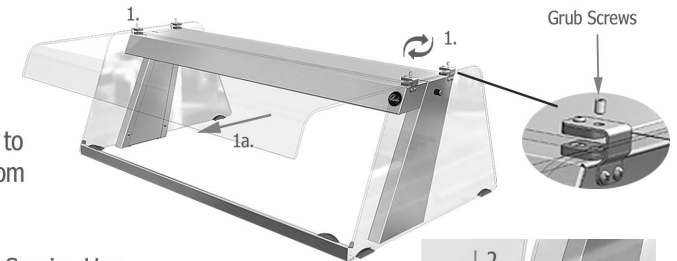

#### Repositioning Top Glass For Assisted Service Use.

2. Stand the flat face of the removed glass (as per stage 1) in the plastic locators at the front of the display (to take the weight).

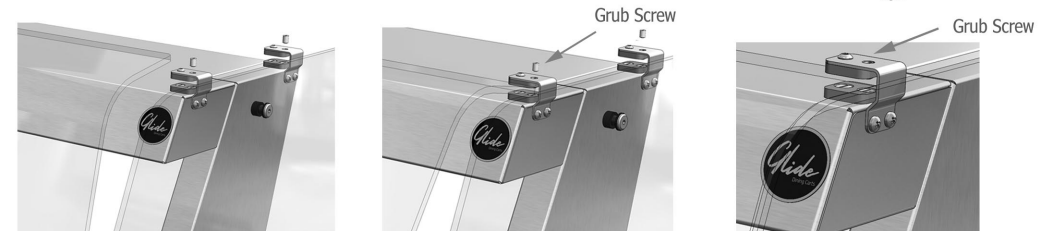
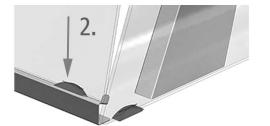

3. Lean the glass towards the gantry so that the curved section rests on the gantry.
4. The glass can be slid under the front two holding brackets after resting in the locators
5. Tighten the top grub screws to trap the glass against the front of the gantry nose. Do not overtighten this screw.

# Glide Plain Top Hot Cupboard (No Gantry/ Hot / Ambient Gantry)





## Operation Continued

### D) Switching Off The Glide Plain Top Hot Cupboard After Serving.

At the end of the serving period, the Glide plain top hotcupboard should be switched off using the rocker switches/dial on the control panel.

 Hot gantry (yellow switch).

 Hot Cupbd. (turn dial to '0').  Main power (green switch).



### E) Best Practice For Using Glide Plain Top Hot Cupboard.

- 1) The hot cupboard should be turned on 45 mins. prior to merchandising.
- 2) Only switch gantry lights on (if fitted) just prior to merchandising.
- 3) Set the hot cupboard dial to the required serving temp. (70-75 deg C) when turning unit on.
- 4) Ensure the sliding hot cupboard doors are not being left open when in use. Heat loss & temperature recovery time should be allowed for after closing doors prior to serving.
- 5) Dishes/plates/pre-cooked food should be introduced above required serving temperature.  
The hot cupboard is designed to maintain pre-cooked food at serving temperature. It is not designed to heat food from cold.
- 6) If there are only a few food containers held in hot cupboard, move these to the lower shelf, closer to the heater element.
- 7) Product should be stirred regularly to ensure heat distribution within the food.
- 8) Cast iron dishes are not suitable for use, as the cast metal removes heat from food whilst the dish is slowly warmed up again after cooking/ oven transfer.
- 9) Allow min. 45 mins. from switching the cabinet on, prior to merchandising.
- 10) Do not site the cabinet in a location where draughts can enter the heated storage space.
- 11) Turn the thermostat control fully on during warm up period, then adjust to suit if required.
- 12) The ambient room temperature must be above 18 degrees C before operating the cabinet.
- 13) Hot gantry use above the steel cupbd. worktop is only for short term holding.

### F) Hot Gantry Lamps - If Fitted.

#### Operational Use Of The Quartz Heat Lamps.

The 200w jacketed lamps heat up rapidly and are extremely hot, never touch the lamps when they are switched on. **Do not touch the lamps with bare fingers as oil deposits from the skin can cause the lamp to fail.**

The glass outer sleeve protects the filament from falling into food if the fitting fails.

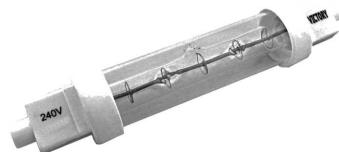

## Maintenance

### G) Replacing Glide End Glass (If Hot/Ambient LED Gantry Fitted).

To replace or remove the end glass from the Glide gantry, the following process is required:

1. Remove the M6 x 35mm connector bolt, shoulder washer & spacer behind that attach the side glass at the top of the post.
  2. Lift the glass up and out from the two side glass locators on the frame.
- The reverse process is used to replace the end glass.



1. Bolt Removal

### Replacing Glide Island Hot Gantry Glass (If Fitted).

To replace the island top glass, remove one end glass as described above (Section G Item 1 & 2).

3. Access can be gained to the two glass clamps that hold island top glass in place.
  4. Undo all four grub screws that hold the island top glass in position.
  5. Remove screws that hold each glass clamp in place, (they are fastened to the side of the gantry post).
  6. Slide the glass clamps off the end of the island top glass.
- The island top glass can be removed from the gantry. Reinstatement is a reverse of this process.

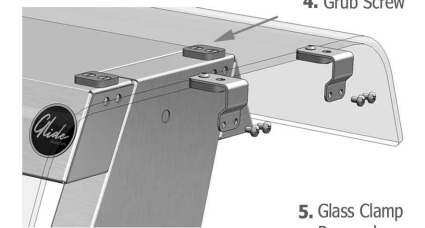

4. Grub Screw

5. Glass Clamp Removal

### H) Switching Off The Plain Top Hot Cupboard For Maintenance.

Before commencing any cleaning or maintenance operation, the display must be isolated from the mains supply by removing the supply plug from the socket.

### I) Maintaining/Replacing The Quartz Heat Lamps (If Fitted).

The life of the lamps will be extended if they are cleaned weekly when cold, using methylated spirits & a cotton pad. Do not touch the lamps with bare fingers as oil deposits from the skin can cause the lamp to fail. The lamps are mounted in the gantry canopy head. When replacing the lamp, ensure the display is isolated and replace the lamp, ensuring no skin contact is made with the fitting during the operation.



I. Lamp replacement avoiding skin contact with the fitting

Lamps used are 'jacketed' 200 watt quartz infrared bulbs, not tungsten bulbs used in domestic lighting.

# Glide Plain Top Hot Cupboard (No Gantry/ Hot / Ambient Gantry)



## Maintenance Continued

### J) Cleaning The Hot Cupboard Area (After Isolation From Electrical Supply).

The base of the hotcupboard contains the fan assisted heating element, within a protective steel cover. Above the heating unit are two heavy duty shelves which are adjustable in height.

**Removing/ Adjusting The Shelves.** Each shelf consist of two removable lengths of steel box section, supported each end by a bracket which clips into the wall of the cupboard base.

Across each piece of steel box section are a series of wired chrome grid shelves, they hook over the box section shelf support and are suitably sized for easy removal. Once these are lifted out it is possible to lift out the box section shelf supports to give access to the cupboard base. Deep cleaning can then be undertaken. Never hose down, wash, submerge or rinse electrical parts on the display.

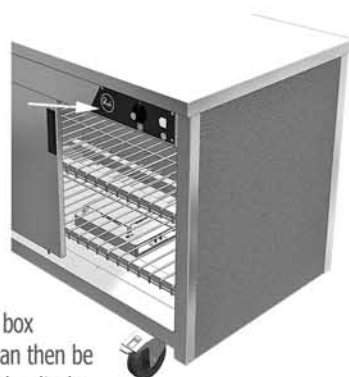

**Removing Hot Cupboard Doors.** To aid access for cleaning of the cupboard area, remove the sliding doors:

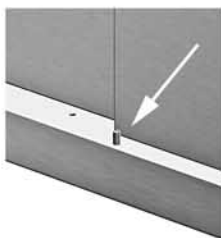

1. Remove the outer door guide pin by unscrewing and set this aside (to refit later).

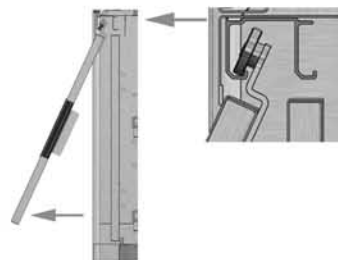

2. Tilt the outer door forwards and lift it slightly to release it from the door guide track. Do the same with the inner door to remove. (Reverse the process to refit, re-fit the outer door guide pin last).



### K) Power Supply Failure To The Display

In the event that the unit will not switch on e.g. none of the neon on/ off switches illuminate, check and replace the plug top fuse, ensure the same rated fuse is replaced. If this does not resolve the problem, call your equipment provider.



### L) Using The S/Steel Folding Tubular Tray Rail - If Fitted.

The Glide dining cart may be fitted with a folding tubular s/steel tray rail. Lift upwards to engage the rail in the horizontal position. To fold down for transport etc. lift upwards by the rear rail before lowering into the vertical position.

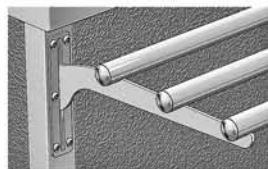

Tray Rail In Use



Tray Rail Folded Down

### L) Using The S/Steel Folding Tray Slide - If Fitted.

The Glide dining cart may also be fitted with a folding s/steel tray slide. Lift upwards to engage the tray slide horizontally.

To fold down for transport etc. lift upwards by the rear edge before lowering into the vertical position.

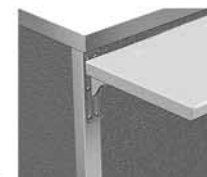

Tray Slide In Use



Tray Slide Folded Down



Tray Slide Fitted

### M) General Cleaning Of The Glide Plain Top Hot Cupboard

Before commencing any cleaning operation, the unit must be isolated. The glass sneeze screen (if fitted) can be cleaned as required using a proprietary minimum odour glass cleaner. Stainless steel surfaces can be cleaned with a non abrasive cream cleaner or a damp cloth with a mild detergent. Never hose down, wash, submerge or rinse electrical parts on the display.



Plain Top Hot Cupbd. Hot Gantry & Tray Rail

### N) Maintaining The Appearance Of The Glide Ceran Top Hot Cupboard

To help maintain the displays' original appearance, a regular daily cleaning routine should be adhered to using the following guidelines.

1. After use, wipe the display with a soft, damp, soapy cloth and rinse with clean water, preferably warm or hot. This action should remove most substances.
2. For heavy duty substances, including oil, grease & water-borne deposits, the use of a multi purpose cream cleaner on a soft, damp cloth will remove deposits.
3. Where the display has a directionally polished grain, any cleaning with abrasives should be carried out along the direction of the grain to prevent scratching.
4. Always remove wet cleaning aids from the surface after use, to avoid water marks/stains.
5. If required, dry the display after use with a soft dry cloth or towel.
6. The gantry section (if fitted) should be cleaned with a damp cloth only.



Plain Top Hot Cupbd. No Gantry

### N) Glide Plain Top Hot Cupboard Models

Code	Description	Capacity (Gn)	Dimensions (L x D x H mm)	Depth With Tray Slide Up/ Down	Weight (kg)	Total Power (kW)		
						No Gantry	+ Hot Gantry	+Amb. Gantry
GHCP2	Glide Plain Top Hot.Cupd No Gantry	2-1	825 x 700 x 900	1000/ 740mm	45	1.83	2.23	1.83
GHCP3	Glide Plain Top Hot.Cupd No Gantry	3-1	1175 x 700 x 900	1000/ 740mm	67	1.83	2.43	1.84
GHCP4	Glide Plain Top Hot.Cupd No Gantry	4-1	1525 x 700 x 900	1000/ 740mm	90	1.83	2.63	1.84
GHCP5	Glide Plain Top Hot.Cupd No Gantry	5-1	1875 x 700 x 900	1000/ 740mm	112	1.83	2.83	1.85



# Troubleshooting Guide - Glide Plain Top Hot Cupbd. (& Hot Gantry Option)

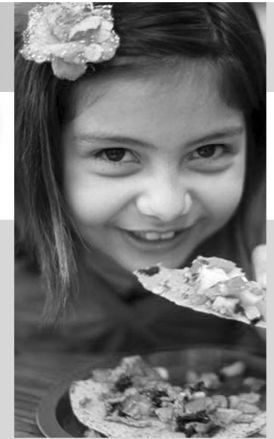

## Problem

## Possible Cause

## Solutions

### Plain Top Hot Cupboard - No Power/ No Illuminated Rocker Switches On.



1. Is green illuminated 'power on' switch switched on ?
2. Is the hot gantry or hot cupboard heating turned on at the control panel ?
3. Is operator / cleaning staff switching unit off at counter MCB or a wall socket ?
4. End User / Installer to check the fuse in the 13 amp plug top.
5. Has fuse tripped in incoming power circuit breaker supply or is the RCD turned off ?
6. Is yellow illuminated 'hot gantry' switch switched on ? Is it illuminated when on ?

1. End User to maintain
2. End User to rectify ( operational issue )
3. End User to rectify ( operational issue )
4. End User / Installer to maintain
5. End User to replace suitably sized fuse.
6. End User to replace lamp /CED service engineer to repair

### Plain Top Hot Gantry - Not Maintaining Food Temperature.



1. Are heated quartz lamps all working.
2. Is produce being held too long under the hot gantry (food supply chain issue)
3. Is too much produce being held in containers (food should be displayed level with container top)
4. Is a ceiling mounted air conditioning draft present over display (Hold napkin over display to test)
5. Are drafts present from open entrance doors/ windows/ corridors (Hold napkin over display to test)

1. End User / Installer to replace 200w jacketed quartz infra red halogen lamps.
2. End User to rectify, gantry is for short term holding only when no ceran or bain marie top.
3. End User to rectify, gantry is for short term holding only when no ceran or bain marie top.
4. End User to re-direct/ switch off air conditioning/ reposition hot cupboard away from draught.
5. End User to eliminate draught over display surface/ reposition hot cupboard.

### Hot Cupboard Not Maintaining Food Temperature.



1. Has the thermostat control knob position been altered/ turned down ?
2. Are the sliding/ hinged hot cupboard doors being left open ?
3. Is the food being introduced above the required serving temperature ?
4. Has the hot cupboard been pre-heated before introduction of pre-cooked food/ plates. ?
5. Is short term storage of food in the cupboard area imminent prior to display ?
6. Are there only a few food containers within ?

1. End User to adjust thermostat control knob to max. on control panel.
2. Heat loss and temperature recovery time should be allowed for after closing doors.
3. The hot cupboard is designed to maintain pre-cooked food at serving temperature. It is not designed to heat food from cold.
4. A suitable warm up period is required before use of the hot storage areas.
5. Food should be presented onto the ceran top/ hot gantry as soon as practical to benefit from both base and top heat.
6. Move the containers to the lower shelf, closer to the heater element.



### Glide Electrical Socket Connections.

Most Glide mobile units are operated by 13A plug top connected to a dedicated single socket outlet (SSO) (13A), unless its' power supply exceeds 13A. *If connected to a double socket outlet, care must be taken not to exceed the circuit capacity.*

**Glide Electrical Trailing Lead Protection.** CED recommend the use of proprietary cable covers to protect overground trailing leads, reduce trip hazards, limit accidental electrical partial plug disconnection and to keep wire safe from impact damage, as damaged cable wire can cause an electrical fault. HSE GOV.UK Guidance On Managing Temporary Electrical Installations Re: Cabling advises: "Route cables to minimise tripping hazards or potential mechanical damage...Give particular care to the position of cable connections. You can also use **cable ramps** or similar to protect cables running overground across route ways to help avoid them becoming tripping hazards".



Proprietary Cable Cover.

Code	Description	Capacity (Gn)	Dimensions (L x D x H mm)	Depth With Tray Slide Up/ Down	Weight (kg)	Total Power (kW)		
						No Gantry	+ Hot Gantry	+ Amb Gantry
GHCP2	Glide Plain Top Hot.Cupd No Gantry	2-1	825 x 700 x 900	1000/ 740mm	45	1.83	2.23	1.83
GHCP3	Glide Plain Top Hot.Cupd No Gantry	3-1	1175 x 700 x 900	1000/ 740mm	67	1.83	2.43	1.84
GHCP4	Glide Plain Top Hot.Cupd No Gantry	4-1	1525 x 700 x 900	1000/ 740mm	90	1.83	2.63	1.84
GHCP5	Glide Plain Top Hot.Cupd No Gantry	5-1	1875 x 700 x 900	1000/ 740mm	112	1.83	2.83	1.85

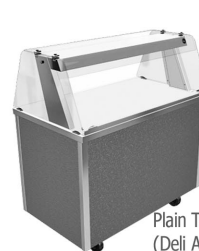

Plain Top H C (Deli Amb. Gantry)



Plain Top H C (No Gantry)

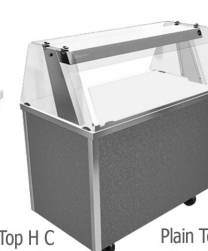

Plain Top H C (Hot Gantry)



Plain Top H C (Island Amb. Gantry)



# Glide Bain Marie (Dry) Hot Cupbd. (& Hot/Hot Island Gantry)



## Operation

### Bain Marie Hot Cupboard (No Gantry) Bain Marie Hot Cupboard & Hot Gantry



B.Marie & H Cupb. On-Off-Adjust Power On-Off



B.Marie & H Cupb. On-Off-Adjust Gantry Power On-Off On-Off

Glide dry bain marie hot cupboard (no gantry) & hot gantry versions are designed for the temporary storage of pre-cooked food whilst service is in progress, as well as preheating plates & dishes.

**Hot Cupboard.** The cupboard is heated via a fan assisted heating element and is fitted with removable sliding doors and removable, adjustable height chrome grid shelves, in manageable sections for easy cleaning. The cupboard holding temperature is adjustable by thermostat & is dependent on the food type, amount of food in container, etc. (It is important to always keep sliding hotcupboard doors closed when unit is heating).

**Dry Bain Marie Top.** The bain marie is also controlled by the hot cupboard thermostat. The model features a bain marie section with removable container supports, formed in the worktop to accept up to 150mm deep Gn containers (not included). The containers are heated by both suspended elements and residual heat from the hot cupboard underneath.

**Hot Gantry (If Fitted).** The hot gantry is controlled by neon on/off switch & provides infra red top heat to the surface of the food on display. The heat lamps in the gantry are a 'jacketed' safety bulb. The reversible toughened glass gantry can be positioned for self help or assisted service operation. (Factory set as self help sneeze screen). An island hot gantry version is also available.

**Dry Bain Marie Hot Cupboard (No Gantry).** For best performance always use lids on Gn containers when not serving & stir food in containers regularly, to distribute base heat in the food.

### A) Switching On The Glide Dry B. Marie Hot Cupboard (No Gantry) Or Hot Gantry Version.

**Mains Power On-Off.** (Green Illuminating On/Off Switch)  
The mains power supply is controlled by the green on/off switch. Ensure the display is plugged in to the supply socket and the socket is switched on. The switch will illuminate when on.

**Hot Gantry - If Fitted** (Yellow On/Off Switch)  
To turn the quartz heat lighting on above the bain marie surface, use the yellow on/off switch. The quartz heat lighting is housed in the gantry above the display and will heat the surface of the food. Stir food regularly to distribute the top heat within. The switch will illuminate when on.

**Dry Bain Marie/ Hot Cupboard Adjustment.** (Thermostatic Control Knob)  
Both the bain marie & hotcupboard are switched on using the thermostatic control knob. Turning the knob clockwise increases the temperature. This will turn on the fan assisted heating element. Depending on the size of the unit, the heat up time may vary.

For temporary storage of food always set above 85C. (if being presented on the bain marie imminently). The general hot cupboard temperature shown is an average indication, as storage within the cupboard changes the airflow direction. (Temperature adjustment can be made using the control knob).  
**The dry b.marie cupboard is supplied with a 3m lead & 13amp UK plug (13A 230v 50Hz)**

**B) Optional B. Marie Inserts - 1/1 Gn** (Use With Hot Gantry Option).  
**Carving Insert.** The 1-1 Gn spiked carving lid & 20mm juice collection tray used underneath, both can sit on the removable b.marie container supports.

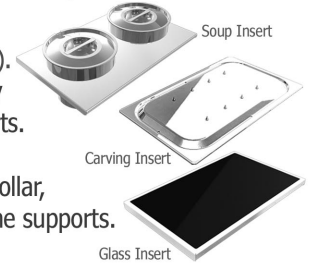

**2 x 4.5 Lt. Soup Container Insert.** The 1-1 Gn insert c/w s/steel support collar, includes 2 no. 4.5 litre soup or gravy containers & lids. This also sits on the supports.

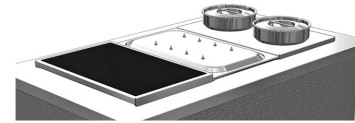

**Hot Glass Insert.** The 1-1 Gn hot glass insert & s/steel surround collar is ideal for sauce dishes and short term holding under the gantry. This will also fit on the bain marie container supports.

### C) Reversing Hot Gantry Glass - Self Help To Assisted Service. (If Fitted).

The display is fitted with 6mm toughened curved top glass. The glass is not designed for objects to be placed on top of it or used as a serve over. Due consideration should be given to overloading/scratching if items are placed on the glass. The glass can be reversed from self help to assisted service position.

#### Removing Or Replacing Top glass.

**1.** Undo the grub screws on the top of the gantry  
**1a.** This allows the curved top glass to slide forward, to lift out and away from the gantry.

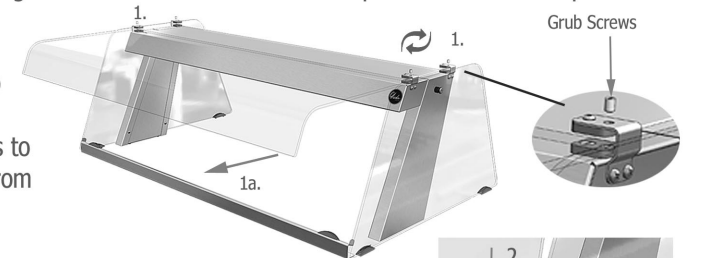

#### Repositioning Top Glass For Assisted Service Use.

**2.** Stand the flat face of the removed glass (as per stage 1) in the plastic locators at the front of the display (to take the weight).

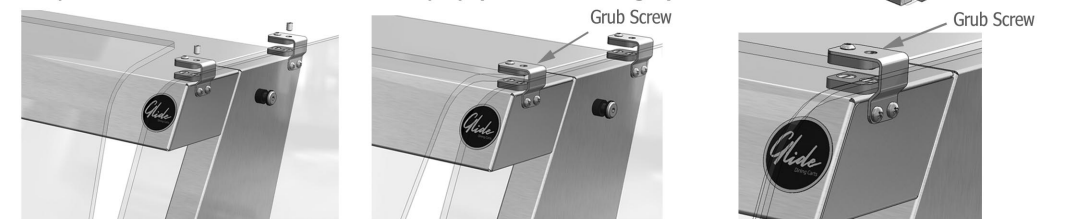

**3.** Lean the glass towards the gantry so that the curved section rests on the gantry.

**4.** The glass can be slid under the front two holding brackets after resting in the locators

**5.** Tighten the top grub screws to trap the glass against the front of the gantry nose. Do not overtighten this screw.

# Glide Bain Marie (Dry) Hot Cupbd. (& Hot/Hot Island Gantry)



## Operation Continued

### D) Switching Off The Glide Dry B. Marie Hot Cupboard After Serving.

At the end of the serving period, the Glide dry b.marie hotcupboard should be switched off using the rocker switches/dial on the control panel.

Hot gantry (yellow switch). Main power (green switch).

Bain marie Top & Hot Cupbd. (turn dial to '0').



### E) Best Practice For Using Glide Dry B.Marie Hot Cupboard.

- 1) The unit should only be turned on 45 mins. prior to merchandising.
- 2) Only switch gantry lights on (if fitted) just prior to merchandising.
- 3) Set the hot cupboard/bain marie dial to the required serving temp. (70-80 deg C) when turning unit on.
- 4) Gn containers should always be placed in each aperture of bain marie top, to stop heat loss.
- 5) Do not use the heated bain marie for reheating or cooking purposes.
- 6) If the unit has no hot gantry fitted, all Gn food containers must be used with a lid.
- 7) Product should be stirred regularly to ensure heat distribution within the food.
- 8) If food is not maintaining temperature, adjust the base heat control knob to increase heat.
- 9) Pre cooked food should be introduced at or above the required serving temperature.
- 10) Do not site the cabinet in a location where draughts can enter the heated display space.
- 11) The ambient room temperature must be above 18 degrees C before operating the cabinet.
- 12) B.marie accessories like glass insert, carving lid, soup insert must be used with hot gantry fitted.

### (Ceran Top) Recommended Food Types

#### Breakfast

*Long Term Holding (lunch period)*

Baked beans, tomatoes, bacon, sausage, black pudding, mushrooms, hash browns

#### Lunch/Dinner

*Long Term Holding (lunch period)*

Stews, curry, chilli dishes, sliced meats in gravy or sauce, vegetables (dry or in liquid), ribs with sauce, chicken portions

#### Breakfast/Brunch

*Short Term Holding*

(15-20 minutes)  
Omlettes, fried/ boiled eggs, baked potatoes

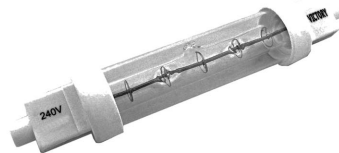

#### Lunch/Dinner

*Short Term Holding (15-20 minutes)*

Battered fish, chips/ fries

### F) (Hot Gantry) Operational Use Of The Quartz Heat Lamps

The 200w jacketed lamps heat up rapidly and are extremely hot, never touch the lamps when they are switched on. **Do not touch the lamps with bare fingers as oil deposits from the skin can cause the lamp to fail.** The glass outer sleeve protects the filament from falling into food if the fitting fails.

## Maintenance

### G) Replacing The Glide End Glass (If Hot Gantry Fitted).

To replace or remove the end glass from the Glide hot gantry, the following process is required:

1. Remove the M6 x 35mm connector bolt, shoulder washer & spacer behind, that attach the side glass at the top of the post.
  2. Lift the glass up and out from the two side glass locators on the frame.
- The reverse process is used to replace the end glass.



### Replacing Glide Island Hot Gantry Glass (If Fitted).

To replace the island top glass, remove one end glass as described above (Section G Item 1 & 2).

3. Access can be gained to the two glass clamps that hold island top glass in place.
  4. Undo all four grub screws that hold the island top glass in position.
  5. Remove screws that hold each glass clamp in place, (they are fastened to the side of the gantry post).
  6. Slide the glass clamps off the end of the island top glass.
- The island top glass can be removed from the gantry. Reinstatement is a reverse of this process.

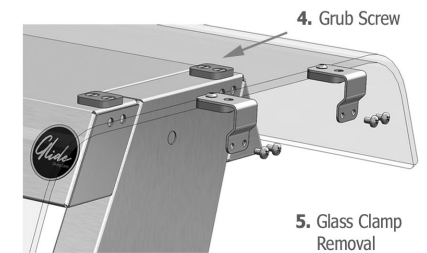

### H) Switching Off The Dry B.Marie Hot Cupboard For Maintenance.

Before commencing any cleaning or maintenance operation, the display must be isolated from the mains supply by removing the supply plug from the socket.

### I) Maintaining/Replacing The Quartz Heat Lamps

The life of the lamps will be extended if they are cleaned weekly when cold, using methylated spirits & a cotton pad. Do not touch the lamps with bare fingers as oil deposits from the skin can cause the lamp to fail. The lamps are mounted in the gantry canopy head. When replacing the lamp, ensure the display is isolated and replace the lamp, ensuring no skin contact is made with the fitting during the operation.



**I.** Lamp replacement avoiding skin contact with the fitting

Lamps used are 'jacketed' 200 watt quartz infrared bulbs, not tungsten bulbs used in domestic lighting.



# Glide Bain Marie (Dry) Hot Cupbd. (& Hot/Hot Island Gantry)



## Maintenance Continued

### J) Cleaning The Hot Cupboard Area (After Isolation From Electrical Supply).

The base of the hotcupboard contains the fan assisted heating element, within a protective steel cover. Above the heating unit are two heavy duty shelves which are adjustable in height.

**Removing/ Adjusting The Shelves.** Each shelf consist of two removable lengths of steel box section, supported each end by a bracket which clips into the wall of the cupboard base.

Across each piece of steel box section are a series of wired chrome grid shelves, they hook over the box section shelf support and are suitably sized for easy removal. Once these are lifted out it is possible to lift out the box section shelf supports to give access to the cupboard base.

Deep cleaning can then be undertaken.

Never hose down, wash, submerge or rinse electrical parts on the display.

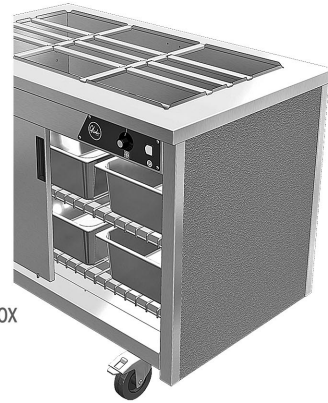

**Removing Hot Cupboard Doors.** To aid access for cleaning of the cupboard area, remove the sliding doors:

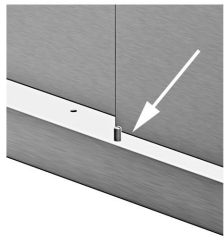

1. Remove the outer door guide pin by unscrewing and set this aside (to refit later).

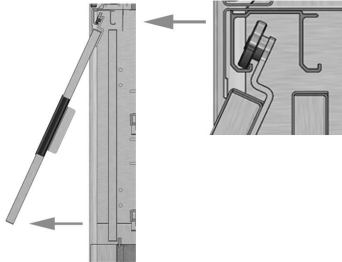

2. Tilt the outer door forwards and lift it slightly to release it from the door guide track. Do the same with the inner door to remove. (Reverse the process to refit, re-fit the outer door guide pin last).

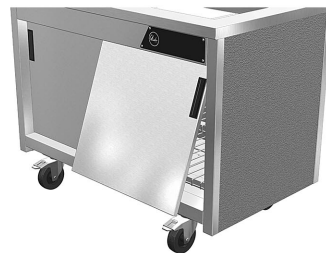

3. In the event the fan assisted heating unit in the hot cupboard base does not work, the fan or heater element should be changed by a suitable qualified electrician or service engineer.

### K) Power Supply Failure To The Display

In the event that the unit will not switch on e.g. none of the neon on/ off switches illuminate, check and replace the plug top fuse, ensuring the same rated fuse is replaced.

If this does not resolve the problem, call your equipment provider.



### L) Use Of The Removable Bain Marie Container Supports.

A series of gastronorm (Gn) container supports are provided with the bain marie worktop. Gn containers must always be placed in the apertures of the bain marie top, to retain heat when in use. The supports that run front to back will support the fitting of 1/1 Gn, 2/3 Gn or 1/3 Gn containers. The dividing container supports that attach to these will allow a 1/1 Gn section to be divided up in to a mix of 3x 1/9 Gn, 2x 1/6 Gn & 1x 1/3 Gn containers.



### M) General Cleaning Of The Glide Dry B. Marie Hot Cupboard.

Before commencing any cleaning operation, the unit must be isolated. The glass sneeze screen (if fitted) can be cleaned as required using a proprietary minimum odour glass cleaner. Stainless steel surfaces can be cleaned with a non abrasive cream cleaner or a damp cloth with a mild detergent. Never hose down, wash, submerge or rinse electrical parts on the display.



### N) Maintaining The Appearance Of The Glide Dry B. Marie Hot Cupbd.

To help maintain the displays' original appearance, a regular daily cleaning routine should be adhered using the following guidelines.

1. After use, wipe the display with a soft, damp, soapy cloth and rinse with clean water, preferably warm or hot. This action should remove most substances encountered.
2. For more heavy duty substances, including oil, grease and water-borne deposits, the use of a multi purpose cream cleaner applied with a soft, damp cloth will remove the deposits.
3. Where the display has a directionally polished grain, any cleaning with abrasives should be carried out along the direction of the grain to prevent scratching.
4. Always remove wet cleaning aids from the surface after use, to avoid formation of water marks/stains.
5. If required, dry the display after use with a soft dry cloth or towel.
6. The gantry section should be cleaned with a damp cloth only.





# Troubleshooting Guide - Glide Dry BM Hot Cupbd. (& Hot Gantry)

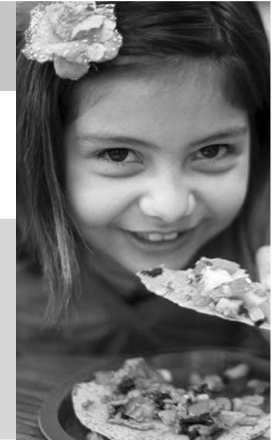

## Problem

## Possible Cause

## Solutions

**Dry B.Marie Hot Cupboard - No Power/ No Illuminated Rocker Switches On.**

1. Is green illuminated 'power on' switch switched on ?
2. Is the hot gantry switch, hot cupboard & b. marie heating dial turned to on at the control panel ?
3. Is operator / cleaning staff switching unit off at counter MCB or a wall socket ?
4. End User / Installer to check the fuse in the 13 amp plug top.
5. Has fuse tripped in incoming power circuit breaker supply or is the RCD turned off ?
6. Is yellow illuminated 'hot gantry' switch switched on ? Is it illuminated when on ?

1. End User to maintain
2. End User to rectify ( operational issue )
3. End User to rectify ( operational issue )
4. End User / Installer to maintain
5. End User to replace suitably sized fuse.
6. End User to replace lamp /CED service engineer to repair

**Bain Marie Top Not Maintaining Food Temperature.**

1. (No Gantry Model Only) Are lids being used with the presentation dishes ?
2. Are heated quartz lamps all working (If hot gantry fitted).
3. Is the suspended bain marie heat element under the food containers not hot ?
4. Are there Gn containers in each aperture of the b.marie top ?
5. Are Gn containers damaged/ don't sit correctly on the container supports (max.150mm deep)
6. Is produce being introduced at correct temperature to b.marie (food supply chain issue)
7. Is too much produce being held in containers (food should be displayed level with container top)
8. Is a ceiling mounted air conditioning draft present over display (Hold napkin over display to test)
9. Are drafts present from open entrance doors/ windows/ corridors (Hold napkin over display to test)

1. End User to provide lids to limit heat loss from containers.
2. End User / Installer to replace 200w jacketed quartz infra red halogen lamps.
3. CED service engineer to remove cover tray/ replace heater element.
4. End User to display Gn containers in each aperture to stop heat loss from open areas.
5. End User to ensure max. 150mm deep containers used/ container perimeter edge is flat.
6. End User to rectify. ( food supply chain issue )
7. End User to rectify ( operational issue )
8. End User to re-direct/ switch off/ re-site air conditioning or move display away from draught.
9. End User to eliminate draft over display surface.

**Hot Cupboard Not Maintaining Food Temperature.**

1. Has the thermostat control knob position been altered/ turned down ?
2. Are the sliding/ hinged hot cupboard doors being left open ?
3. Is the food being introduced above the required serving temperature ?
4. Has the hot cupboard been pre-heated before introduction of pre-cooked food/ plates. ?
5. Is short term storage of food in the cupboard area imminent prior to display ?
6. Are there only a few food containers within ?

1. End User to adjust thermostat control knob to max. on control panel.
2. Heat loss and temperature recovery time should be allowed for after closing doors.
3. The hot cupboard is designed to maintain pre-cooked food at serving temperature. It is not designed to heat food from cold.
4. A suitable warm up period is required before use of the hot storage areas.
5. Food should be presented onto the ceran top/ hot gantry as soon as practical to benefit from both base and top heat.
6. Move the containers to the lower shelf, closer to the heater element.



### Glide Electrical Socket Connections.

Most Glide mobile units are operated by 13A plug top connected to a dedicated single socket outlet (SSO) (13A), unless its' power supply exceeds 13A. *If connected to a double socket outlet, care must be taken not to exceed the circuit capacity.*

**Glide Electrical Trailing Lead Protection.** CED recommend the use of proprietary cable covers to protect overground trailing leads, reduce trip hazards, limit accidental electrical partial plug disconnection and to keep wire safe from impact damage, as damaged cable wire can cause an electrical fault. HSE GOV.UK Guidance On Managing Temporary Electrical Installations Re: Cabling advises: "Route cables to minimise tripping hazards or potential mechanical damage...Give particular care to the position of cable connections. You can also use **cable ramps** or similar to protect cables running overground across route ways to help avoid them becoming tripping hazards".



Proprietary Cable Cover.

Code	Description	Capacity (Gn)	Dimensions (L x D x H mm)	Depth With Tray Slide Up/ Down	Weight (kg)	Total Power (kW)	
						No Gantry	+ Hot Gantry
GHBM2	Glide Dry B.Marie Hot.Cupd No Gantry	2-1	825 x 700 x 900	1000/ 740mm	45	2.58	2.08
GHBM3	Glide Dry B.Marie Hot.Cupd No Gantry	3-1	1175 x 700 x 900	1000/ 740mm	67	2.83	2.53
GHBM4	Glide Dry B.Marie Hot.Cupd No Gantry	4-1	1525 x 700 x 900	1000/ 740mm	90	2.83	2.73
GHBM5	Glide Dry B.Marie Hot.Cupd No Gantry	5-1	1875 x 700 x 900	1000/ 740mm	112	2.83	2.93



Dry B.Marie H C (No Gantry)



Dry B.Marie H C (Hot Gantry)



Dry B.Marie H C (Island Hot Gantry)



# Glide Bain Marie (Wet & Dry) Hot Cupbd. (& Hot/Hot Island Gantry)



## Operation

### Wet-Dry B.Marie Hot Cupbd. (No Gantry)

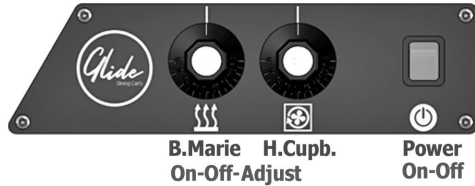

### Wet-Dry B.Marie Hot Cupbd. & Hot Gantry



Glide wet-dry bain marie hot cupboard (no gantry) & hot gantry versions are designed for the temporary storage of pre-cooked food whilst service is in progress, as well as preheating plates & dishes.

**Hot Cupboard.** The cupboard is heated via a fan assisted heating element and is fitted with removable sliding doors and removable, adjustable height chrome grid shelves, in manageable sections for easy cleaning. The cupboard holding temperature is adjustable by thermostat & is dependent on the food type, amount of food in container, etc. (It is important to always keep sliding hotcupboard doors closed when unit is heating).

**Wet-Dry Bain Marie Top.** The bain marie is controlled by a separate thermostat & features a bain marie section with removable container supports, formed in the worktop for up to 150mm deep Gn containers (not included). The containers are heated by elements underneath the fully welded tank. Water can be manually added for wet well use also. A water level tank fill indicator & swivel drain are included.

**Hot Gantry (If Fitted).** The hot gantry is controlled by neon on/off switch & provides infra red top heat to the surface of the food on display. The heat lamps in the gantry are a 'jacketed' safety bulb. The reversible toughened glass gantry can be positioned for self help or assisted service operation. (Factory set as self help sneeze screen). An island hot gantry version is also available.

**Wet-Dry Bain Marie Hot Cupboard (No Gantry).** For best performance always use lids on Gn containers when not serving & stir food in containers regularly, to distribute base heat in the food.

### A) Switching On The Glide Wet-Dry B. Marie Hot Cupbd. (No Gantry)/ Hot Gantry Version.

**Mains Power On-Off.** (Green Illuminating On/Off Switch)  
The mains power supply is controlled by the green on/off switch. Ensure the display is plugged in to the supply socket and the socket is switched on. The switch will illuminate when on.

**Hot Gantry - If Fitted** (Yellow On/Off Switch)  
To turn the quartz heat lighting on above the bain marie surface, use the yellow on/off switch. The quartz heat lighting is housed in the gantry above the display and will heat the surface of the food. Stir food regularly to distribute the top heat within. The switch will illuminate when on.

**Wet-Dry Bain Marie & Hot Cupboard On/Off & Adjustment.** (Thermostatic Control Knobs)  
Both the bain marie & hotcupboard are switched on using a thermostatic control knob. Turning the knob clockwise increases the temperature, turning on the fan assisted heating element or bain marie suspended elements. Depending on the size of the unit, the heat up time may vary.

Always set above 85 degrees C. when presenting food on the bain marie imminently. The general hot cupboard temperature shown is an average indication, as storage within the cupboard changes the airflow direction. (Temperature adjustment can be made using the control knob). The wet-dry b.marie cupbd. (no gantry) has a 3m lead & 13 amp UK plug (13A 230v 50Hz). 3/1, 4/1 & 5/1Gn models with hot gantry option are fitted with 16A/32A commando plug.

**B) Optional B. Marie Inserts - 1/1 Gn** (Use With Hot Gantry Option).  
**Carving Insert.** The 1-1 Gn spiked carving lid & 20mm juice collection tray used underneath, both can sit on the removable b.marie container supports.



**2 x 4.5 Lt. Soup Container Insert.** The 1-1 Gn insert c/w s/steel support collar, includes 2 no. 4.5 litre soup or gravy containers & lids. This also sits on the supports.

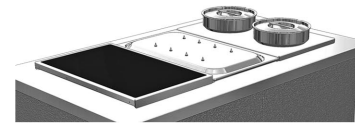

**Hot Glass Insert.** The 1-1 Gn hot glass insert & s/steel surround collar is ideal for sauce dishes and short term holding under the gantry. This will also fit on the bain marie container supports.

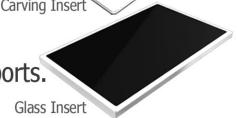

### C) Reversing Hot Gantry Glass - Self Help To Assisted Service. (If Fitted).

The display is fitted with 6mm toughened curved top glass. The glass is not designed for objects to be placed on top of it or used as a serve over. Due consideration should be given to overloading/scratching if items are placed on the glass. The glass can be reversed from self help to assisted service position.

#### Removing Or Replacing Top glass.

1. Undo the grub screws on the top of the gantry
- 1a. This allows the curved top glass to slide forward, to lift out and away from the gantry.

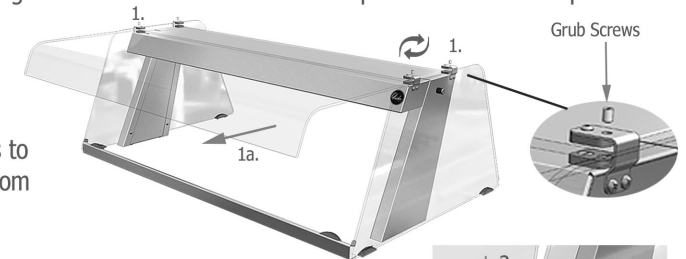

#### Repositioning Top Glass For Assisted Service Use.

2. Stand the flat face of the removed glass (as per stage 1) in the plastic locators at the front of the display (to take the weight).
3. Lean the glass towards the gantry so that the curved section rests on the gantry.
4. The glass can be slid under the front two holding brackets after resting in the locators
5. Tighten the top grub screws to trap the glass against the front of the gantry nose.



# Glide Bain Marie (Wet & Dry) Hot Cupbd. (& Hot/Hot Island Gantry)



## Operation Continued

### D) Switching Off The Glide Wet-Dry B. Marie Hot Cupboard.

The Glide wet-dry b.marie hotcupbd. should be switched off as below.

Hot gantry (yellow switch). Main power (green switch).

Bain marie Top & Hot Cupbd. (turn each dial to '0').



The swivel drain & lever arm handle within the hot cupbd. can be used to empty waste water.

### E) Best Practice For Using Glide Wet-Dry B.Marie Hot Cupboard.

- 1) The unit should only be turned on 45 mins. prior to merchandising.
- 2) Only switch gantry lights on (if fitted) just prior to merchandising.
- 3) Set hot cupboard & b.marie dials to their required serving temp. (75-85 deg C) when turning unit on.
- 4) Gn containers should always be placed in each aperture of bain marie top, to stop heat loss.
- 5) Do not use the heated bain marie for reheating or cooking purposes.
- 6) If the unit has no hot gantry fitted, all Gn food containers must be used with a lid.
- 7) Product should be stirred regularly to ensure heat distribution within the food.
- 8) If food is not maintaining temperature, adjust the base heat control knob to increase heat.
- 9) Pre cooked food should be introduced at or above the required serving temperature.
- 10) Do not site the cabinet in a location where draughts can enter the heated display space.
- 11) The ambient room temperature must be above 18 degrees C before operating the cabinet.
- 12) B.marie accessories like glass insert, carving lid, soup insert must be used with hot gantry fitted.
- 13) Wet Well B.Marie Use. Always ensure the water level is filled to the tank fill guide, prior to use.

### Bain Marie Top: Recommended Food Types

#### Breakfast

*Long Term Holding (lunch period)*

Baked beans, tomatoes, bacon, sausage, black pudding, mushrooms, hash browns

#### Lunch/Dinner

*Long Term Holding (lunch period)*

Stews, curry, chilli dishes, sliced meats in gravy or sauce, vegetables (dry or in liquid), ribs with sauce, chicken portions

#### Breakfast/Brunch

*Short Term Holding*

(15-20 minutes)  
Omlettes, fried/ boiled eggs, baked potatoes

#### Lunch/Dinner

*Short Term Holding (15-20 minutes)*

Battered fish, chips/ fries

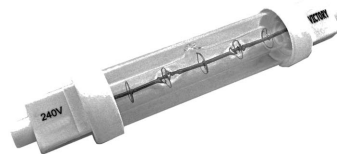

### F) (Hot Gantry) Operational Use Of The Quartz Heat Lamps

The 200w jacketed lamps heat up rapidly and are extremely hot, never touch the lamps when they are switched on. **Do not touch the lamps with bare fingers as oil deposits from the skin can cause the lamp to fail.** The glass outer sleeve protects the filament from falling into food if the fitting fails.

## Maintenance

### G) Replacing The Glide End Glass (If Hot Gantry Fitted).

To replace or remove the end glass from the Glide hot gantry, the following process is required:

1. Remove the M6 x 35mm connector bolt, shoulder washer & spacer behind, that attach the side glass at the top of the post.
  2. Lift the glass up and out from the two side glass locators on the frame.
- The reverse process is used to replace the end glass.



1. Bolt Removal

### Replacing Glide Island Hot Gantry Glass (If Fitted).

To replace the island top glass, remove one end glass as described above (Section G Item 1 & 2).

3. Access can be gained to the two glass clamps that hold island top glass in place.
  4. Undo all four grub screws that hold the island top glass in position.
  5. Remove screws that hold each glass clamp in place, (they are fastened to the side of the gantry post).
  6. Slide the glass clamps off the end of the island top glass.
- The island top glass can be removed from the gantry. Reinstatement is a reverse of this process.

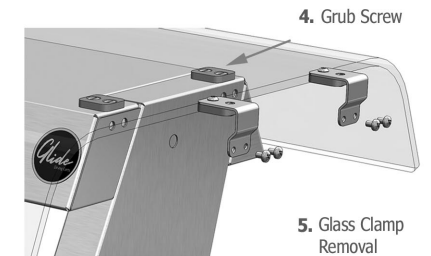

4. Grub Screw

5. Glass Clamp Removal

### H) Switching Off The Wet-Dry B.Marie Hot Cupboard For Maintenance.

Before commencing any cleaning or maintenance operation, the display must be isolated from the mains supply by removing the supply plug from the socket.

### I) Maintaining/Replacing The Quartz Heat Lamps

The life of the lamps will be extended if they are cleaned weekly when cold, using methylated spirits & a cotton pad. Do not touch the lamps with bare fingers as oil deposits from the skin can cause the lamp to fail. The lamps are mounted in the gantry canopy head. When replacing the lamp, ensure the display is isolated and replace the lamp, ensuring no skin contact is made with the fitting during the operation.



I. Lamp replacement avoiding skin contact with the fitting

Lamps used are 'jacketed' 200 watt quartz infrared bulbs, not tungsten bulbs used in domestic lighting.

# Glide Bain Marie (Wet & Dry) Hot Cupbd. (& Hot/Hot Island Gantry)



## Maintenance Continued

### J) Cleaning The Wet-Dry B.Marie Hot Cupboard Area (After Isolation From Electrical Supply).

The base of the hotcupboard contains the fan assisted heating element, within a protective steel cover. Above the heating unit are two heavy duty shelves which are adjustable in height.

**Removing/ Adjusting The Shelves.** Each shelf consist of two removable lengths of steel box section, supported each end by a bracket which clips into the wall of the cupboard base.

Across each piece of steel box section are a series of wired chrome grid shelves, they hook over the box section shelf support and are suitably sized for easy removal. Once these are lifted out it is possible to lift out the box section shelf supports to give access to the cupboard base/commence deep cleaning. Never hose down, wash, submerge or rinse electrical parts on the display.

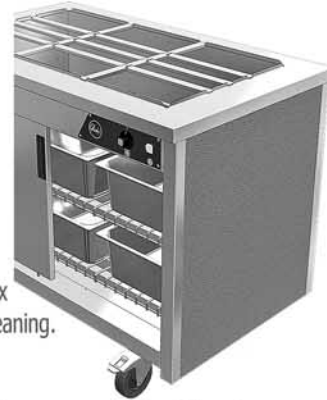

**Removing Hot Cupboard Doors.** To aid access for cleaning of the cupboard area, remove the sliding doors:

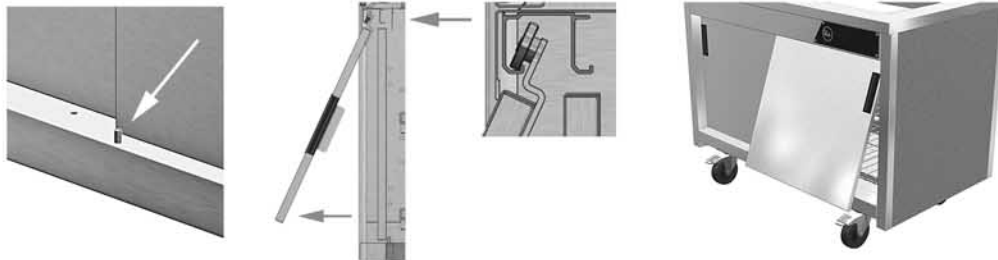

**1.** Remove the outer door guide pin by unscrewing and set this aside (to refit later).

**2.** Tilt the outer door forwards and lift it slightly to release it from the door guide track. Do the same with the inner door to remove. (Reverse the process to refit, re-fit the outer door guide pin last).

**3.** In the event the fan assisted heating unit in the hot cupboard base does not work, the fan or heater element should be changed by a suitable qualified electrician or service engineer.

### K) Power Supply Failure To The Display

**Model With 13A Plug.** If the wet-dry bain marie will not switch on e.g. none of the neon on/ off switches illuminate or thermostat controls do not heat unit, check & replace the plug top fuse, ensure the same rated fuse is replaced. If this does not resolve the problem, call your equipment provider.

**Model With 16A/32A Commando Plug.** If none of the neon on/ off switches illuminate or thermostat controls do not heat unit, remove the operator right hand end panel by removing screw to the panel bottom. Lift off & check the 3 fuses holders that provide separate circuit protection for the hot cupbd (5A) the wet-dry bain marie (10A) or the hot gantry (5A). These fuses should be changed by a suitable qualified electrician or service engineer.



13A Plug Fuse Location



16/32A Commando Plug Fuses Location

### L) Use Of The Removable Wet-Dry Bain Marie Container Supports.

A series of gastronorm (Gn) container supports are provided with the bain marie worktop. Gn containers must always be placed in the apertures of the bain marie top, to retain heat when in use. The supports that run front to back will support the fitting of 1/1 Gn, 2/3 Gn or 1/3 Gn containers. The dividing container supports that attach to these will allow a 1/1 Gn section to be divided up into a mix of 3x 1/9 Gn, 2x 1/6 Gn & 1x 1/3 Gn containers.



### M) General Cleaning Of The Glide Wet-Dry B. Marie Hot Cupboard.

Before commencing any cleaning operation, the unit must be isolated. The glass sneeze screen (if fitted) can be cleaned as required using a proprietary minimum odour glass cleaner. Stainless steel surfaces can be cleaned with a non abrasive cream cleaner or a damp cloth with a mild detergent. Never hose down, wash, submerge or rinse electrical parts on the display.



### N) Maintaining The Appearance Of The Glide Wet-Dry B. Marie Hot Cupbd.

To help maintain the displays' original appearance, a regular daily cleaning routine should be adhered using the following guidelines.

1. After use, wipe the display with a soft, damp, soapy cloth and rinse with clean water, preferably warm or hot. This action should remove most substances encountered.
2. For more heavy duty substances, including oil, grease and water-borne deposits, the use of a multi purpose cream cleaner applied with a soft, damp cloth will remove the deposits.
3. Where the display has a directionally polished grain, any cleaning with abrasives should be carried out along the direction of the grain to prevent scratching.
4. Always remove wet cleaning aids from the surface after use, to avoid formation of water marks/stains.
5. If required, dry the display after use with a soft dry cloth or towel.
6. The gantry section should be cleaned with a damp cloth only.
7. The inside of the bain marie tank can be cleaned with a damp scotchbrite pad and a little detergent, preferably whilst still warm after use. It should then be wiped dry with a clean cloth. If used as a wet well, waste water can be drained out prior using the swivel drain underneath the tank.



Wet-Dry B.Marie Hot Cupbd. & Hot Gantry



Wet-Dry B.Marie Hot Cupboard No Gantry



Wet-Dry B. Marie Hot Cupbd. & Hot Island Gantry





# Troubleshooting Guide - Glide Wet-Dry BM Hot Cupbd. (& Hot Gantry)



## Problem

## Possible Cause

## Solutions

**Wet-Dry B.Marie Hot Cupbd - No Power/ No Illuminated Rocker Switches On.**

1. Is green illuminated 'power on' switch switched on ?
2. Is the hot gantry switch, hot cupboard & b. marie heating dial turned to on at the control panel ?
3. Is operator / cleaning staff switching unit off at counter MCB or a wall socket ?
4. End User / Installer to check the fuse in the 13 amp plug top/ fuse protection for commando plug.
5. Has fuse tripped in incoming power circuit breaker supply or is the RCD turned off ?
6. Is yellow illuminated 'hot gantry' switch switched on ? Is it illuminated when on ?

1. End User to maintain
2. End User to rectify ( operational issue )
3. End User to rectify ( operational issue )
4. End User / Qualified Electrician/ Installer to maintain
5. End User to replace suitably sized fuse.
6. End User to replace lamp /CED service engineer to repair

**Wet-Dry Bain Marie Top Not Maintaining Food Temperature.**

1. (No Gantry Model Only) Are lids being used with the presentation dishes ?
2. Are heated quartz lamps all working (If hot gantry fitted).
3. Are the suspended bain marie heat elements under the tank not making tank hot ?
4. Are there Gn containers in each aperture of the b.marie top ?
5. Are Gn containers damaged/ don't sit correctly on the container supports (max.150mm deep)
6. Is produce being introduced at correct temperature to b.marie (food supply chain issue)
7. Is too much produce being held in containers (food should be displayed level with container top)
8. Is a ceiling mounted air conditioning draft present over display (Hold napkin over display to test)
9. Are drafts present from open entrance doors/ windows/ corridors (Hold napkin over display to test)

1. End User to provide lids to limit heat loss from containers.
2. End User / Installer to replace 200w jacketed quartz infra red halogen lamps.
3. CED service engineer to remove cover tray/ replace heater element/s.
4. End User to display Gn containers in each aperture to stop heat loss from open areas.
5. End User to ensure max. 150mm deep containers used/ container perimeter edge is flat.
6. End User to rectify. ( food supply chain issue )
7. End User to rectify ( operational issue )
8. End User to re-direct/ switch off/ re-site air conditioning or move display away from draught.
9. End User to eliminate draft over display surface.

**Hot Cupboard Not Maintaining Food Temperature.**

1. Has the thermostat control knob position been altered/ turned down ?
2. Are the sliding/ hinged hot cupboard doors being left open ?
3. Is the food being introduced above the required serving temperature ?
4. Has the hot cupboard been sufficiently pre-heated before introduction of pre-cooked food/ plates ?
5. Is short term storage of food in the cupboard area imminent prior to display ?
6. Are there only a few food containers within ?

1. End User to adjust thermostat control knob to max. on control panel.
2. Heat loss and temperature recovery time should be allowed for after closing doors.
3. The hot cupboard is designed to maintain pre-cooked food at serving temperature. It is not designed to heat food from cold.
4. A suitable warm up period is required before use of the hot storage areas.
5. Food should be presented onto the ceran top/ hot gantry as soon as practical to benefit from both base and top heat.
6. Move the containers to the lower shelf, closer to the heater element.



### Glide Electrical Socket Connections.

Most Glide mobile units are operated by 13A plug top connected to a dedicated single socket outlet (SSO) (13A), unless its' power supply exceeds 13A. *If connected to a double socket outlet, care must be taken not to exceed the circuit capacity.*

**Glide Electrical Trailing Lead Protection.** CED recommend the use of proprietary cable covers to protect overground trailing leads, reduce trip hazards, limit accidental electrical partial plug disconnection and to keep wire safe from impact damage, as damaged cable wire can cause an electrical fault. HSE GOV.UK Guidance On Managing Temporary Electrical Installations Re: Cabling advises: "Route cables to minimise tripping hazards or potential mechanical damage...Give particular care to the position of cable connections. You can also use **cable ramps** or similar to protect cables running overground across route ways to help avoid them becoming tripping hazards".



Proprietary Cable Cover.

Code	Description	Capacity (Gn)	Dimensions (L x D x H mm)	Depth With Tray Slide Up/ Down	Weight (kg)	Total Power (kW)	
						No Gantry	+ Hot Gantry
GHBMW2	Glide Wet/Dry BM Hot.Cupd (No Gantry)	2-1	825 x 700 x 900	1000/ 740mm	45	2.43	2.83 13A
GHBMW3	Glide Wet/Dry BM Hot.Cupd (No Gantry)	3-1	1175 x 700 x 900	1000/ 740mm	67	2.93	3.53 16A
GHBMW4	Glide Wet/Dry BM Hot.Cupd (No Gantry)	4-1	1525 x 700 x 900	1000/ 740mm	90	2.93	3.73 32A
GHBMW5	Glide Wet/Dry BM Hot.Cupd (No Gantry)	5-1	1875 x 700 x 900	1000/ 740mm	112	2.93	3.93 32A



Wet-Dry B.Marie H C (No Gantry)



Wet-Dry B.Marie H C (Hot Gantry)



Wet-Dry B.Marie H C (Island Hot Gantry)



# Glide Soup Station (Dry Heat) Bain Marie

## Operation Soup Station (Dry Heat) Bain Marie



Soup B.Marie On-Off- Adjust Power On-Off

**About.** The Glide soup station is a mobile dry heat bain marie & ambient storage cupboard with front/ side fascia panels, a reversible s/steel bain marie insert & a cupboard with two tiers of wire rack shelving below. Each shelf is adjustable in height and fully removable for cleaning. The operator side rear s/steel sliding doors are also removable. The soup station features 2 x 4.5 litre containers with

notched lids (for ladles) and a removable drip tray section. The containers can be used to hold gravy, custard etc. by adjusting the thermostat control.

**Reversible Bain Marie Top.** The soup station has a reversible bain marie insert within a s/steel worktop. Standard BM insert position is Assisted Service = 2x 4.5 lt. soup pots to front, 1x drip tray to rear. Optional BM insert position is Self Help = 1x drip tray to front, 2x 4.5 lt. soup pots to rear. (The insert lifts out for reversing to a self help position & allows simple repositioning of the suspended hairpin heating element under). Containers are supplied with notched lids. For best performance always use lids on containers & stir food in containers regularly, to distribute base heat in the food. Introduce produce at or above required serving temperature.

**Ambient Storage Cupboard.** The ambient storage cupboard underneath has 2 tier adjustable internal grid shelves, both are removable for cleaning. The rear sliding s/steel cupboard doors are also removable for access. The unit has lockable castors and control panel to operator side. It is supplied with a 3m lead and a 13A UK plug top (0.75 Kw). The soup station features thermostatic bain marie control & a neon mains power on/off switch.

### A) Switching On The Glide Soup Station (Dry Heat) Bain Marie.

#### Ⓜ Mains Power On-Off. (Green Illuminating On/Off Switch)

The mains power supply is controlled by the green on/off switch. Ensure the display is plugged in to the supply socket and the socket is switched on. The switch will illuminate when on.

**Ⓜ Soup Station (Dry Heat) Bain Marie Adjustment.** (Thermostatic Control Knob) The soup station bain marie is switched on using the thermostatic control knob. Turning the knob clockwise increases the temperature. This will turn on the suspended heat element under the containers. The heat element can be re-positioned if the soup bain marie section is preferred as a self help operation (with the drip tray facing the customer). Set the thermostat to *required soup serving temperature* when heating the soup station up for 45 mins. prior to use. Further adjustment can be made with the control knob during use.

### B) Glide Electrical Socket Connections.

Most Glide mobile units are operated by 13A plug top connected to a dedicated single socket outlet (SSO) (13A), unless its' power supply exceeds 13A. *If connected to a double socket outlet, care must be taken not to exceed the circuit capacity.*



2 x 4.5 litre containers & notched lids

Proprietary Cable Cover.



F)

## Maintenance

### C) Repositioning The Soup Bain Marie Collar To Self Help.

After isolating the electrical supply for the soup station by removing the supply plug from it's socket, allow sufficient time for the heater element to cool down if the unit has been in use.

1. Lift the assisted service soup station bain marie collar (with the containers & the drip tray assembly) up and away from the worktop & place this to one side exposing heater element.

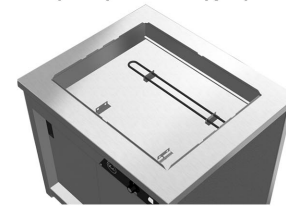

2. The heating element can be repositioned by bending the locating tabs to release it.



3. Once element is released, place the element in the second position and secure with the easy fold tabs.



4. Then refit the soup BM collar on the worktop in self help position as shown above.

### D) Cleaning & Accessing Ambient Storage Cupboard Area.

Removing/ Adjusting The Shelves. (After Isolation From Electrical Supply).

Each shelf consist of two removable lengths of steel box section. Across these are wired chrome grid shelves that hook over the box section shelf support. Once these are lifted out it is possible to lift out the box section shelf supports to give access. Deep cleaning can then be undertaken. Cleaning. Stainless steel surfaces can be cleaned with a non abrasive cream cleaner or a damp cloth with a mild detergent.



### E) Removing Cupboard Doors.

For cleaning access to the cupboard area, remove the sliding doors:

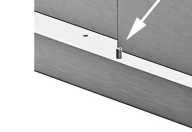

1. Remove the outer door guide pin by unscrewing and set this aside (to refit later).

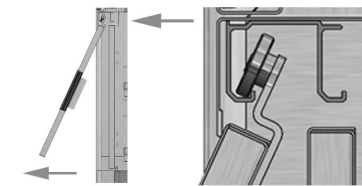

2. Tilt the outer door forwards and lift it slightly to release it from the door guide track. Do the same with the inner door to remove. (Reverse the process to refit, re-fit the outer door guide pin last).



**F) Glide Electrical Trailing Lead Protection.** CED recommend the use of cable covers to protect overground trailing leads, reduce trip hazards, limit accidental electrical partial plug disconnection and to keep wire safe from impact damage, as damaged cable wire can cause an electrical fault. HSE GOV.UK Guidance On Managing Temporary Electrical Installations Re: Cabling advises: "Route cables to minimise tripping hazards or potential mechanical damage...Give particular care to the position of cable connections. You can also use **cable ramps** or similar to protect cables running overground across route ways to help avoid them becoming tripping hazards".

# Glide Ambient Multideck ( & Roller Shutter Version )

## Operation

### Ambient Multideck (Rear Doors)



Light/ Power On-Off

The display features 3 no. 10mm thick glass shelves (adjustable in height & angle) & an ambient s/ steel storage well below (gastronorm depth). The glass shelving has product stops & 40mm(h) ticket strip holder to the front edge of each shelf. An ambient cupboard is provided below, with removable sliding s/steel cupboard doors & two levels of removable grid shelves. The display may also be fitted with a night blind or a lockable pull down roller shutter.

### A) Switching On/ Off The Ambient Multideck Display Lighting

 The display has been fitted with LED lighting. Turn the mains power supply switch on (green neon on/off switch), this will turn the display lighting on. The 4000k LED light is housed in a diffuser in the canopy head of the display. To switch off lighting, depress the on/ off power button again. Models with rear doors have light/power switch control in the rear valance panel. Wall sited models with a rear fixed back panel have the light/power switch in the gantry nosing at high level.

### B) Adjusting The Shelves In Height

1. Take hold of the glass shelf & shelf edge ticket display mounting (attached to the front edge). Lift the glass shelf up and away from the supporting shelf brackets.
2. Tilt the glass shelf and carefully lift it out of the display (or lay on top of the one below)
3. Reposition the brackets at the desired height
4. Clip the brackets to the rear frame like A) for a flat positioned or B) for an inclined position shelf.



### C) Shelf Edge Ticket Display Mounting Assembly

Each shelf is fitted with a ticket display mounting assembly, which allows for the fitting of a standard 40mm ticket strip. The spacing behind the ticket strip helps acts as a product stop and retains produce on the shelf.

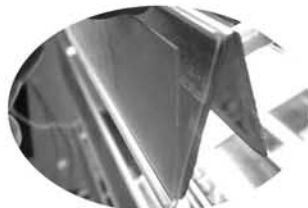

### Ambient Multideck (Fixed Back)

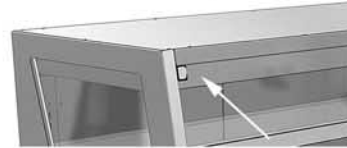

Light/ Power On-Off

## Operation

### D) Positioning The Display

To prevent movement the unit is fitted with lockable castors, whether the unit is fixed back (wall sited) or has rear doors (freestanding) the lockable castors are fitted to both customer and operator side. To lock the castor press down on the metal flange above the wheel with the foot. To release the castor/ move the unit, simply flip the lever upwards to release the wheel. (see fig. 1)



Amb. m.deck (rear doors)



Amb. m.deck & shutter (fixed back)



Amb. m.deck & shutter (rear doors)



fig.1

### E) Rear Access Doors - Operation

If the display has doors, the unit can be loaded from the rear with product.

1. The door is held in the closed position by magnetic gaskets to both top & bottom rear frame and detent action hinges.
2. The hinges allow the door to be held open in two positions, a midway position and fully open.
3. The door has a steel ledge to its' inner face, acting as an infill to the bottom glass shelf when closed, when open, it allows clearance for easier product loading into the deck area.



1. Magnetic Door Gasket



2. Midway Door Position



3. Product Loading Deck Access

### F) Recommended Food Display Layout/ Restocking Tips.



#### Food (Deck Or Shelving Area)

Danish Pastries, muffins, donuts, fruit cake, biscuits, fruit, chocolate, crackers, rice crackers, tacos, crisps, nuts & breakfast cereals. Sandwiches, baguettes, rolls, barmcakes, cheese subject to local health regulations re: display times.

#### Drinks (Deck Area For Heavier Items)

Still & Carbonated, bottled, canned or cartoned, water, dairy, lemonade, wine, beer, lager, fruit juice & health drinks.

**Overloading Shelves.** Due consideration should be given to overloading if placing drinks on the glass shelving. Cans can be placed on the shelves if required but should not be double stacked due to weight considerations. The deck area is the preferred location for this practice.





# Glide Ambient Multideck ( & Roller Shutter Version )

## Maintenance

### G) Switching Off The Ambient Multideck For Maintenance.

Before commencing any cleaning or maintenance operation, the display must be isolated from the mains supply by removing the supply plug from the socket.

**N.B. Switching off just using the On/Off button on the control panel does not fully isolate the unit.**

### H) Replacing LED Light Fittings.

Parts replacement must be undertaken by a competent installer. The fitting is mounted in the gantry canopy head. The LED light is a low maintenance light with a diffuser cover to protect the led's. To replace the light fitting, complete, including the diffuser, the following procedures must be used.

#### Canopy head:



1. Disconnect the light lead that is attached to the side of the fitting.

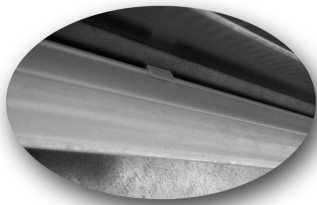

2. The complete LED fitting is retained by 2 no. U - shaped clips.



3. Prize open one face of the clip and lift the fitting out & down. Replacement is the reverse.

### I) Security Roller Shutter: Lock Maintenance.

The multideck may be fitted with a pull down lockable heavy duty security roller shutter. When in the open position the shutter is stored in the overhead canopy section. When pulled down into the closed position and locked, the central lock sends sliding bars into each of the roller shutter guides. Two suited keys are supplied. Periodic maintenance of the lock itself consists of lubricating the lock barrel occasionally with a maintenance spray (such as WD40).



### J) Glide Electrical Socket Connections.

Most Glide mobile units are operated by 13A plug top connected to a dedicated single socket outlet (SSO) (13A), unless its' power supply exceeds 13A. *If connected to a double socket outlet, care must be taken not to exceed the circuit capacity.*



**K) Glide Electrical Trailing Lead Protection.** CED recommend the use of cable covers to protect overground trailing leads, reduce trip hazards, limit accidental electrical partial plug disconnection and to keep wire safe from impact damage, as damaged cable wire can cause an electrical fault. HSE GOV.UK Guidance On Managing Temporary Electrical Installations Re: Cabling advises: "Route cables to minimise tripping hazards or potential mechanical damage...Give particular care to the position of cable connections. You can also use **cable ramps** or similar to protect cables running overground across route ways to help avoid them becoming tripping hazards".



Proprietary Cable Cover.

## Maintenance



Amb. m.deck (rear doors)



Amb. m.deck & shutter (fixed back)



Amb. m.deck & shutter (rear doors)

### L) Cleaning The Main Display Deck.

Routine deep cleaning of the display after product leaks etc. may involve cleaning the main deck area.



1. Fully isolate the display, as described in Maintenance section (Item G),
2. Decant the unit of product, bottles etc. in the base :
3. The stainless steel surface can be cleaned with a non abrasive cream cleaner or a damp cloth with a mild detergent.
4. Never hose down, wash or rinse the deck as there is no drain and the steel base is not a fully welded construction.

### M) General Cleaning.

Before commencing any cleaning operation, the unit must be isolated. The panoramic glass side panels can be cleaned as required using a proprietary minimum odour glass cleaner. Stainless steel surfaces can be cleaned with a non abrasive cream cleaner or a damp cloth with a mild detergent, use mild detergent on plastisol surfaces also. Never hose down, wash, submerge or rinse around the electrical parts on the display.

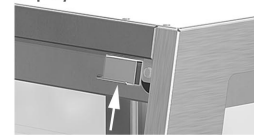

Front glass finger pull

If assisted service glass is fitted, pull the glass forward using the finger pull mounted on the top edge of the glass the glass will tilt forward in the hinge and stop. The inside face of the glass can then be cleaned.

Amb. m.deck & shutter (fixed back)



### N) Maintaining The Appearance Of The Glide Ambient Multideck Display.

To help maintain the displays' original appearance, a regular daily cleaning routine should be adhered to using the following guidelines.

1. After use, switch off/ unplug the ambient multideck. Wipe the display with a soft, damp, soapy cloth and rinse with clean water, preferably warm or hot. This action should remove most substances encountered.
2. For more heavy duty substances, including oil, grease and water-borne deposits, the use of a multi purpose cream cleaner applied with a soft, damp cloth will remove the deposits.
3. Where the display has a directionally polished grain, any cleaning with abrasives should be carried out along the direction of the grain to prevent scratching.
4. Always remove wet cleaning aids from the surface after use, to avoid formation of water marks/stains.
5. If required, dry the display after use with a soft dry cloth or towel.



Amb. m.deck (rear doors)



# Glide Ambient Storage Cupboard (No Gantry/ Hot /Ambient Gantry)

## Operation

### Plain Top Ambient Cupbd. (No Gantry)



### Plain Top Ambient Cupbd. & Gantry



Gantry/Power  
On-Off

**Plain Top Ambient Cupboard.** The Glide ambient storage cupboard is a mobile plain top storage station with external full front/ side fascia panels, a s/steel worktop & a two tier wire rack shelf storage cupboard behind. Each shelf is adjustable in height and fully removable for cleaning. The operator side rear s/steel sliding doors are also removable. With a hot gantry added the task lighting provides those vital last seconds of top heat at food pick up points, in the transfer of plated meals from kitchen to table. By adding either LED light gantries or assisted service deli gantry with glass shelf, the cupboard top can be used for plate, cutlery, condiments or snack selection.

**Ambient LED Gantry/Deli LED Gantry/ Island LED Gantry.** If supplied, the ambient gantry, island ambient gantry or assisted service deli gantry can be added to increase food presentation space, the ambient gantries are all fitted with 4000 kelvin LED lighting & are controlled by an illuminating neon on/off switch. The deli gantry option also includes a glass mid-shelf.

**Hot Gantry.** If supplied, the hot gantry is also controlled by a neon on/off switch & provides short term holding of plated meals under, via infra red top heat to the surface of the food on display. The heat lamps in the gantry are a 'jacketed' safety bulb. The reversible toughened glass hot gantry & ambient LED gantry can be positioned for self help or assisted service operation. (Factory set as self help sneeze screen).

### A) Switching On The Glide Plain Top Ambient Cupboard & Gantry (If Fitted).

**⏻ Mains Power/Hot Or Ambient Gantry Lighting On-Off.** (Green Illuminating On/Off Switch)  
The mains power supply/lighting is controlled by the green on/off switch. Ensure the display is plugged in to the supply socket and the socket is switched on. The switch will illuminate when on. The quartz heat lighting is housed in the gantry above the display and will temporarily heat the surface of the food held below. Stir food regularly to distribute the top heat within. The switch will illuminate when on. The LED gantry has a protective light cover on the fitting to prevent entry into food below if damaged. When fitted with a gantry, the ambient storage cupboard is supplied with a 3m lead & 13A plug.

### B) Glide Electrical Socket Connections.

Most Glide mobile units are operated by 13A plug top connected to a dedicated single socket outlet (SSO) (13A), unless its' power supply exceeds 13A. *If connected to a double socket outlet, care must be taken not to exceed the circuit capacity.*



### C) Gantry Option Types (If Fitted).

**Heated Gantry.** Heated gantry option provides short term hot holding of plated meals under. **Ambient/ Island Or Deli Gantry.** LED reversible glass gantry or island gantry options can be added to increase food presentation space. The deli gantry option also includes a glass mid-shelf.

### D) Reversing Hot/Ambient LED Gantry Glass - Self Help To Assisted Service. (If Fitted).

The display is fitted with 6mm toughened curved top glass. The glass is not designed for objects to be placed on top of it or used as a serve over. Due consideration should be given to overloading/scratching if items are placed on the glass. The glass can be reversed from self help to assisted service position.

#### Removing Or Replacing Top glass.

**1.** Undo the grub screws on the top of the gantry

**1a.** This allows the curved top glass to slide forward, to lift out and away from the gantry.

#### Repositioning Top Glass For Assisted Service Use.

**2.** Stand the flat face of the removed glass (as per stage 1) in the plastic locators at the front of the display (to take the weight).

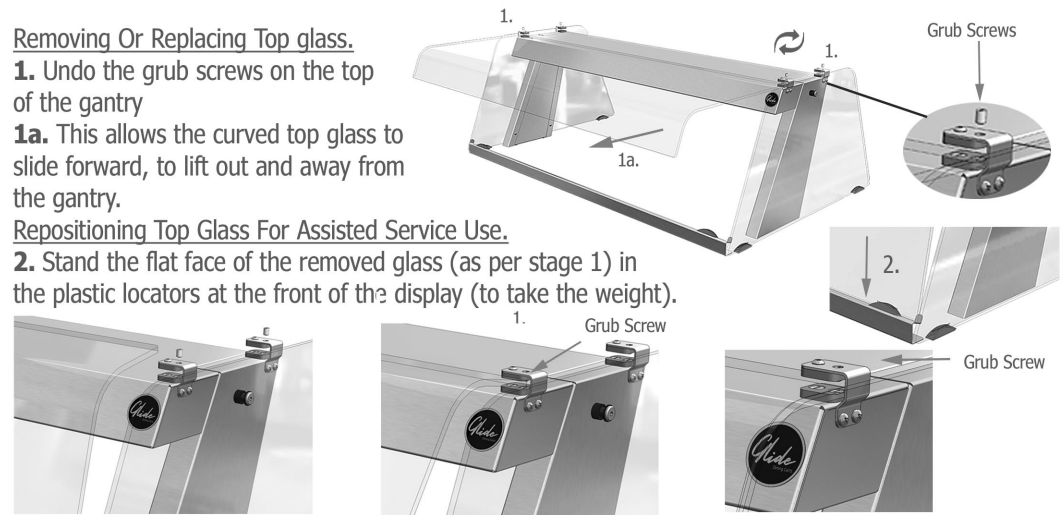

**3.** Lean the glass towards the gantry so that the curved section rests on the gantry.

**4.** The glass can be slid under the front two holding brackets after resting in the locators

**5.** Tighten the top grub screws to trap the glass against the front of the gantry nose. Do not overtighten this screw.

**E) Operational Use Of Hot Gantry Lamps - If Fitted.** The 200w jacketed lamps heat up rapidly and are extremely hot, never touch the lamps when they are switched on. **Do not touch the lamps with bare fingers as oil deposits from the skin can cause the lamp to fail.** The glass outer sleeve protects the filament from falling into food if the fitting fails.



**F) Glide Electrical Trailing Lead Protection.** CED recommend the use of cable covers to protect overground trailing leads, reduce trip hazards, limit accidental electrical partial plug disconnection and to keep wire safe from impact damage, as damaged cable wire can cause an electrical fault. HSE GOV.UK Guidance On Managing Temporary Electrical Installations Re: Cabling advises: "Route cables to minimise tripping hazards or potential mechanical damage...Give particular care to the position of cable connections. You can also use **cable ramps** or similar to protect cables running overground across route ways to help avoid them becoming tripping hazards".

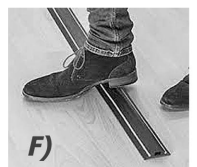

Proprietary Cable Cover.

# Glide Ambient Storage Cupboard (No Gantry/ Hot /Ambient Gantry)

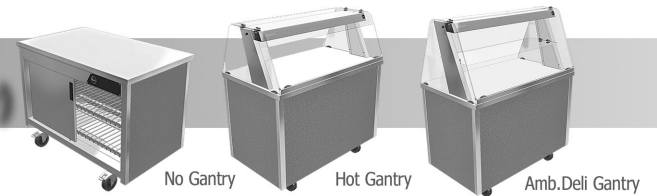

## Maintenance

### G) Replacing Glide End Glass (If Hot/Ambient LED Gantry Fitted).

To replace or remove the end glass from the Glide gantry, the following process is required:

1. Remove the M6 x 35mm connector bolt, shoulder washer & spacer behind, that attach the side glass at the top of the post.
2. Lift the glass up and out from the two side glass locators on the frame. The reverse process is used to replace the end glass.



### Replacing Glide Island Hot Gantry Glass (If Fitted).

To replace the island top glass, remove one end glass as described above (Section G Item 1 & 2).

3. Access can be gained to the two glass clamps that hold island top glass in place.
4. Undo all four grub screws that hold the island top glass in position.
5. Remove screws that hold each glass clamp in place, (they are fastened to the side of the gantry post).
6. Slide the glass clamps off the end of the island top glass. The island top glass can be removed from the gantry. Reinstatement is a reverse of this process.

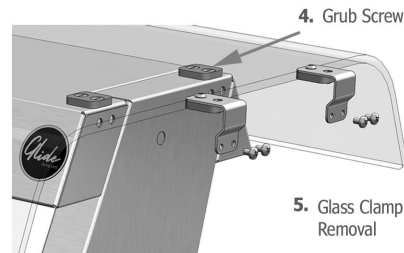

### H) Switching Off The Plain Top Ambient Cupboard For Maintenance.

If gantry is fitted, before commencing any cleaning or maintenance operation, the display must be isolated from the mains supply by removing the supply plug from the socket.

### I) Maintaining/Replacing The Quartz Heat Lamps (If Fitted).

The life of the lamps will be extended if they are cleaned weekly when cold, using methylated spirits & a cotton pad. Do not touch the lamps with bare fingers as oil deposits from the skin can cause the lamp to fail. The lamps are mounted in the gantry canopy head. When replacing the lamp, ensure the display is isolated and replace the lamp, ensuring no skin contact is made with the fitting during the operation.



I. Lamp replacement avoiding skin contact with the fitting

Lamps used are 'jacketed' 200 watt quartz infrared bulbs, not tungsten bulbs used in domestic lighting.

## Maintenance Cont.

### J) Cleaning The Ambient Storage Cupboard

If fitted with a gantry, isolate the cupboard from the power supply first: **Removing/ Adjusting The Shelves.** Each shelf consist of two removable lengths of steel box section, supported each end by a bracket which clips into the wall of the cupboard base.

Across each piece of steel box section are a series of wired chrome grid shelves, they hook over the box section shelf support and are suitably sized for easy removal. Once these are lifted out it is possible to lift out the box section shelf supports to give access to the cupboard base. Deep cleaning can then be undertaken. Never hose down, wash, submerge or rinse electrical parts on the display.



**Removing Cupboard Doors.** To aid access for cleaning of the cupboard area, remove the sliding doors:

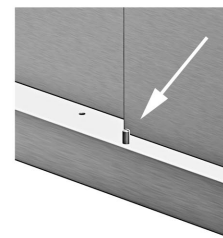

1. Remove the outer door guide pin by unscrewing and set this aside (to refit later).

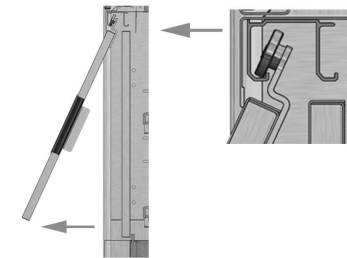

2. Tilt the outer door forwards and lift it slightly to release it from the door guide track. Do the same with the inner door to remove. (Reverse the process to refit, re-fit the outer door guide pin last).

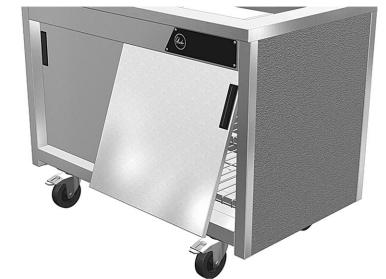

### K) Maintaining The Appearance Of The Glide Ambient Storage Cupboard.

To help maintain the displays' original appearance, a regular daily cleaning routine should be adhered to using the following guidelines.

1. After use, wipe the display with a soft, damp, soapy cloth and rinse with clean water, preferably warm or hot. This action should remove most substances.
2. For heavy duty substances, including oil, grease & water-borne deposits, the use of a multi purpose cream cleaner on a soft, damp cloth will remove deposits.
3. Where the display has a directionally polished grain, any cleaning with abrasives should be carried out along the direction of the grain to prevent scratching.
4. Always remove wet cleaning aids from the surface after use, to avoid water marks/stains.
5. Plastisol surfaces can be cleaned with a mild detergent. If required, dry the display after use with a soft dry cloth or towel.
6. The gantry section (if fitted) should be cleaned with a damp cloth only.



Plain Top  
Amb. Cupd.  
No Gantry



# Glide Cashier Station/ Cutlery & Low Height Tray Pick Up/ Sanitising Unit

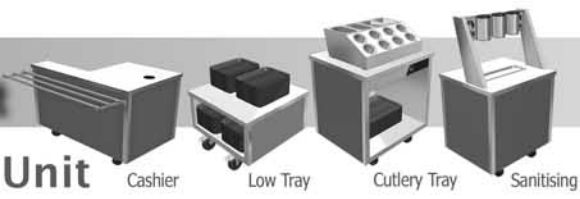

## Cashier Station.

**Operation.** The Glide cashier station features a recessed area for foot rest, to enable a cashier to be seated behind the till. 2 no. cable management ports & a double socket are fitted in the worktop & within the body of the till station, to allow the entry of both data points & power for a till and cash drawer. The till station may be provided with a drop down s/steel tubular tray rail or slide. The station also features lockable castors. A till supply of no more than 3Kw can be accommodated.

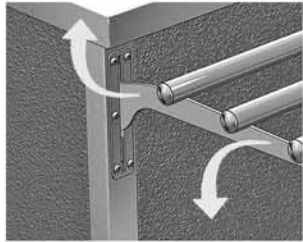

### Using The Tray Slide (If Fitted).

Lifting the tray rail up slightly at the rear releases the tray tube support bracket from the base unit & then allows the tray rail to be lowered down for transport etc. **Raising Tray Slide.** Simply lift the tray rail upwards until it clicks into place in the horizontal position. **Power Supply.** Available as either left or right handed version, the cash station has 3m lead & 13amp UK plug. In the event of power failure check/ replace the same amp fuse.

## Cutlery Tray Pick Up.

**Operation.** The cutlery/tray unit is made in a convenient 2-1 Gn size, 825(l) x 700(d) x 900(h) and can be positioned in a counter run or wall sited to suit the servery layout. The standard open tray cupboard features a s/steel plain worktop & 730mm wide open access tray storage base area. The side base panels are finished in leathergrain plastisol steel, colour merlin grey (BS 18B25), each model comes with lockable castors.

**Cutlery Dispenser Section:** The 235mm (h) self help s/steel cutlery dispenser has rubber feet to prevent surface scratches. The angled self help front face features 8 x Ø115mm perforated steel cutlery containers, for easy cutlery choice. The top surface also houses 4 x 1/4Gn x 100 (d) Gn containers for storage of condiment sachets, napkins etc.



## Low Height Tray Pick Up.

**Operation.** The low height tray pick up unit is a mobile storage stand with full front & sides clad with external fascia panels, a recessed rear tray storage facility, a 304 gd. s/steel worktop and lockable castors. The unit is 500mm high to enable positioning alongside adjacent Glide units, or as freestanding tray collection point at the dining hall entrance. The s/steel worktop is suitable for supporting trays & non electrical counter top equipment also (max 55Kg). The low height tray pick up can be used as a step down area in the counter to position a soup kettle or gravy station. (a localised power supply is required).



## Sanitising Dispenser Unit

The sanitising dispenser unit can be placed in several locations to encourage PPB (personal protective behaviour). This mobile sanitising point has lockable castors. It can be positioned within a counter run to suit the servery layout, or used at the dining hall entrance.

**Operation.** The model has (3)x auto electronic sanitising dispensers offering 1500 dose capacity & a gel storage cupboard under. The dispensers are suitable for high alcohol sanitiser gel  $\geq 60\%$ , have touchless operation from a sensor & use 4x rechargeable AA batteries each (recharging batteries/ battery charger are included).



The s/steel worktop has a removable drip tray (2-4 Gn x 20mm) & the unit has an ambient rear store cupboard c/w removable sliding s/steel doors & grid shelves. By placing your hands underneath the electronic dispenser, the infra red detection cell discharges a measured dose of sanitising gel and it's simple to refill too. The sanitiser has a large dispensing capacity of approx. 500 doses. The slotted window in the electronic dispenser provides easy monitoring of gel level.

### Electronic Sanitiser Dispenser (Alcohol Gel $\geq 60\%$ ).

Each of the 3 Glide sanitising dispensers is hands free to help maintain a hygienic environment. Each dispenser has a gel dispensing capacity 600ml/ appx. 500 doses.

### Maintenance.

The lid of each dispenser can be lifted up when insitu to add more sanitising gel, as required. The slotted window in the electronic dispenser front provides easy monitoring of gel level. When low a battery indicator on the front of the dispenser flashes red. Battery replacement is achieved by sliding the dispenser upwards to release it from the rear mounting bracket. The rear of the dispenser is where the batteries are located behind a lift out flap. Ensure you replace the batteries in the same orientation as they are removed. When operational and in detection mode, a green indicator light flashes on the front.

## Maintenance - Glide Ambient Equipment

### General Cleaning.

Before commencing any cleaning operation, any electrical unit must be isolated (e.g. Cashier Station) Stainless steel surfaces can be cleaned with a non abrasive cream cleaner or a damp cloth with a mild detergent. Plastisol panels can be cleaned with detergent & dried with a soft cloth. Never hose down, wash, submerge or rinse electrical parts on the display.



# Glide Waste Clearing Trolley/ Glide 45 & 90° Corner Infill Units

## 45 & 90° Corner Infill Units

**Operation.** These angled corner infill work stations have lockable castors & can be combined with other dining carts to change the direction of the servery run, whilst continuing the worktop flow. They are finished on all four sides to create internal or external 45° or 90° angles between the adjacent dining carts. Their flexible nature means they can be adapted to different positions, helping ease customer flow around the servery.

**Tray Slides/Rails (If Fitted).** Each corner infill unit has a plain s/steel 304 gd. worktop, front/rear and side base panels in leathergrain plastisol steel, colour merlin grey and lockable castors. Tubular drop - down tray rails or tray slides may be fitted to the outside external angled face of either the 45° or 90° corner infill unit, to continue the detail around the servery perimeter.

(Tray Slide/ Rail Operation & Maintenance is covered on pg. 21)

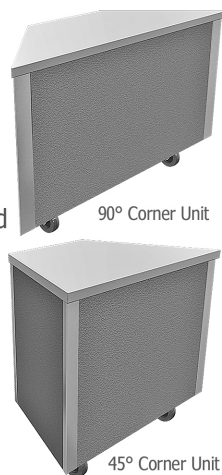

### Operation Of Liquid & Food Waste Area.

Food waste & liquid waste from drinks etc, can be disposed of through the s/steel waste disposal worktop. A removable steel funnel is provided in the top for pouring waste liquid through. Adjacent to the liquid area is an aperture for the disposal/ scrapping of food waste from plates. A drip mould around the top contains any spilled liquid.

A 25 lt liquid bin & a 50 lt. food bin sit under the worktop & can be slid out for emptying.



### Operation Of Paper & Can Disposal, Cutley Collection & Tray/ Plate Storage Areas.

The waste clearing trolley has a central section featuring a removable shelf & tray rest, to assist users to place the dining tray down, prior to disposing of paper, cans and cutlery in the bins behind. When the bins are full this shelf can be lifted out to remove the bins if they are too heavy to lift.

To remove the shelf :

1. Pull the shelf towards yourself a little and then
2. lift the shelf upwards to release it for bin removal access, if required.

**Tray Storage.** Underneath the central tray rest area and the liquid/ food waste sections are storage areas for used dining trays.

**Plate & Dish Storage.** The right hand end of the trolley features a set down area for storing used plates and dishes. It is wide enough to place a dishwasher basket on and below the shelf are runners that will allow for either 2 x baskets or more used tray storage also.

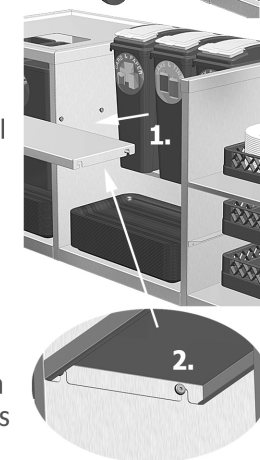

## Waste Clearing Trolley

**General Operation.** The s/steel waste clearing trolley is made in a 5-1Gn size 1875(l) x 675(d) x 900mm (h). It can be used as a freestanding or wall sited unit that suites with the servery layout. The welded worktop area (l.hand end) has two apertures in for food and liquid waste scrapping, with a lift out s/steel wktp. funnel for pouring liquid waste through.

**Layout.** A 520mm wide 2 tier section for plate returns (r.hand end) will also accept dishwash baskets & basket or tray storage underneath. The unit comes with 5 no. removable bins for liquid (25 lt.) + food waste (50 lt.), paper, cans, & cutlery (all 25 lt.), with bin type identification vinyl labels to each. A central tray rest shelf doubles as a bin retainer & lifts out for simple bin removal if required. The rear & side base panels are leathergrain plastisol steel, colour merlin grey, the worktop is 304 gd. s/steel & base is 430 gd. The trolley is fitted with lockable castors.

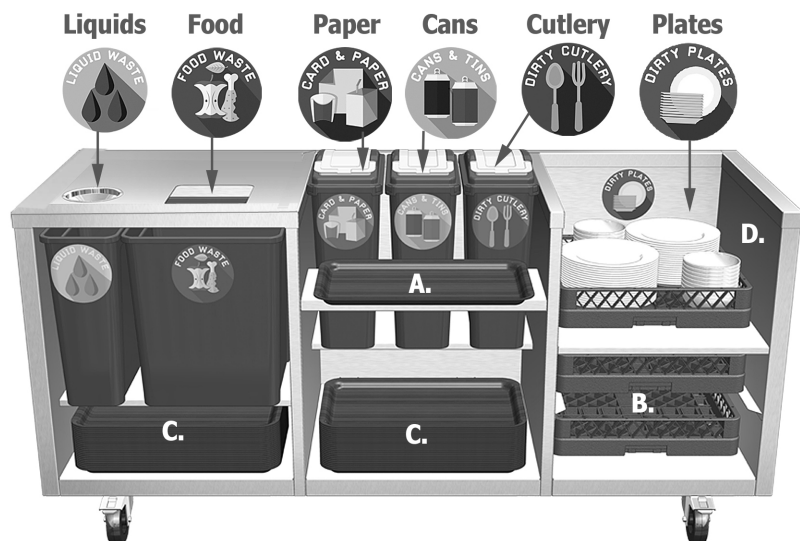

- A.** Removable Tray Rest Shelf/ Bin Retainer
- B.** Dishwash Basket Storage Runners
- C.** Used Tray Storage
- D.** Used Plates Storage

### Low Maintenance.

Easy, cleanable surfaces and a durable design ensure low maintenance for users.

**Operating Locations.** The flexible design means the clearing trolley can be positioned in alcoves or recesses, wall sited or even as back to back free standing waste clearing points in the lunch hall. At the end of the dining period the various bins, plates, baskets and trays can be removed insitu or wheeled into the kitchen area by the catering staff.

## Maintenance - Glide Ambient Equipment

### General Cleaning.

Stainless steel surfaces can be cleaned with a non abrasive cream cleaner or a damp cloth with a mild detergent. Plastisol panels can be cleaned with detergent & dried with a soft cloth. Never hose down, wash, submerge or rinse electrical parts if present on the display.



# Glide Ambient/ Heated Twin Plate Dispenser

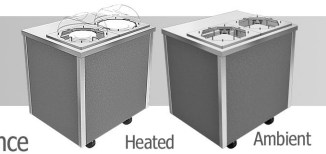

## Operation.

**General Plate Dispenser Use.** The dispenser has two spring loaded, self levelling plate storage sections within a s/steel worktop. Each spring loaded dispenser section is adjusted by lifting the four plate guide rods inwards/ outwards, to enable the storage of various diameter plates, between 8"-12" (205mm-305mm) with a capacity of appx. 53-60 plates each section, depending on type. The springs keep the plates below rising to the top of the dispenser, as plates are removed. Springs can be easily removed to facilitate smaller and lighter weight plates.

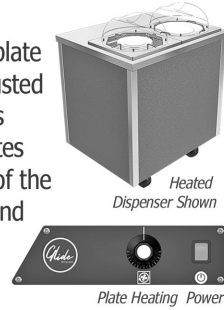

**Heated Dispenser Use.** Each heated plate storage section has a stackable polycarbonate lid, leave these on during the 30 min. plate heating process to retain heat within the dispenser. With lids off the warmed plates will be kept at a touch safe temperature during the serving period. The dispenser has controls to operator side and is supplied with a 3m lead and 13A UK plug top (0.75 Kw). The dispenser heats plates by use of a thermostatic control knob & fan assisted heating, controlling internal airflow at up to 85 degrees C. A neon power on/off switch is fitted on the control panel.

### A) Glide Electrical Socket Connections.

Most Glide mobile units are operated by 13A plug top connected to a dedicated single socket outlet (SSO) (13A), unless its' power supply exceeds 13A. *If connected to a double socket outlet, care must be taken not to exceed the circuit capacity.*

**B) Glide Electrical Trailing Lead Protection.** CED recommend the use of cable covers to protect overground trailing leads, reduce trip hazards, limit accidental electrical partial plug disconnection and to keep wire safe from impact damage, as damaged cable wire can cause an electrical fault. HSE GOV.UK Guidance On Managing Temporary Electrical Installations Re: Cabling advises: "You can also use **cable ramps** or similar to protect cables running overground across route ways to help avoid them becoming tripping hazards".



Proprietary Cable Cover.

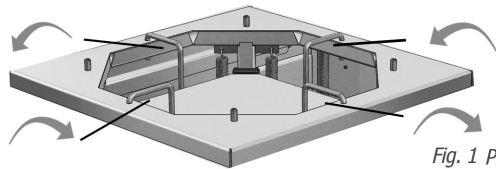

Fig. 1 Plate Guide Adjustment

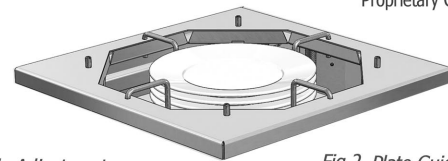

Fig.2 Plate Guide Testing

**C) Setting Dispenser Plate Guides To Suit Plate Diameter.** If the dispenser is a heated model, ensure the unit is electrically isolated & remove the polycarbonate lid (if fitted). Lift up each of the plate guides & turn them outwards or inwards to allow the particular plate diameter to fit inbetween them (Fig. 1). The plates can be between 8"-12" (205mm-305mm) diameter. Test the plate guides are adjusted to suit the required plate diameter by placing a few inside the top of the dispenser (Fig. 2). The diameter is now set.

**D) Setting The Plate Handling Height (Spring Adjustment).** The plate handling height must be set to prevent fingers from getting caught and to avoid the breakage of plates. With both plate dispenser serving elements removed from the base (Fig 3.)

**1.** Insert **twenty** or so plates inside the plate dispenser serving element and watch how it reacts:  
if the stack of plates does not go down far enough, then one or more springs must be removed (remove these springs completely).

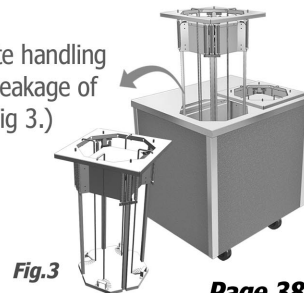
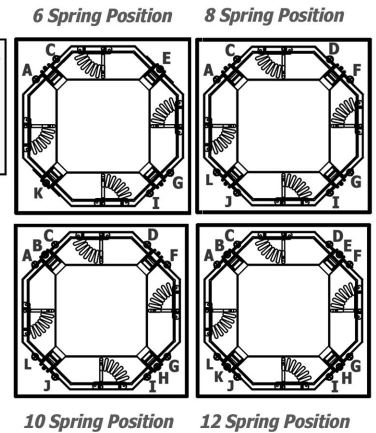

Fig.3

**2. The springs must be removed equally** around the circumference (See section 3 below) until the top plate arrives at the same height as the plate guide bars. Repeat for each dispenser serving element.

**3. Guide: Typical Ø Plate v Qty. & Position Of Springs.**

Ø Plate (Porcelain)	Av. Weight (g)	Av. Height Ea. (mm)	Max. Plates Each Dispenser	Total Weight (Kg)	Qty. Springs Per Dispenser (3.9kg ea.)
203 mm (8")	440	10	53	23.32	6
229 mm (9")	470	11	48	23	6
254 mm (10")	753	12	44	33.13	8
279 mm (11")	916	12	44	40.3	10
305 mm (12")	925	12	44	40.7	10
305 mm (12")* Ceramic*	1.14	13	41	46.74	12



**4.** Refit both plate serving elements previously removed from the trolley base. **The plate dispenser is now ready for use.**

## Maintenance.

### E) General Cleaning Of The Glide Plate Dispenser.

Before commencing cleaning, the unit must be isolated (if hot model). Polycarbonate lids (if fitted) can be cleaned using a glass cleaner & cloth. Stainless steel surfaces can be cleaned with a non abrasive cream cleaner or damp cloth with a mild detergent. Never hose down, wash, submerge or rinse electrical parts on the display.

### F) Maintaining The Appearance Of The Glide Plate Dispenser.

To help maintain the displays' original appearance, a regular daily cleaning routine should be adhered using the following guidelines.

1. After use, wipe the display with a soft, damp, soapy cloth and rinse with clean water, preferably warm or hot. This action should remove most substances encountered. (Disconnect from power supply prior if the unit is heated).
2. For more heavy duty substances, including oil, grease & water-borne deposits, the use of a multi purpose cream cleaner applied with a soft, damp cloth will remove the deposits.
3. Where the display has a directionally polished grain, cleaning with abrasives should be carried out along the direction of the grain to prevent scratching.
4. Always remove wet cleaning aids from the surface after use, to avoid formation of water marks/stains.
5. If required, dry the display after use with a soft dry cloth or towel.

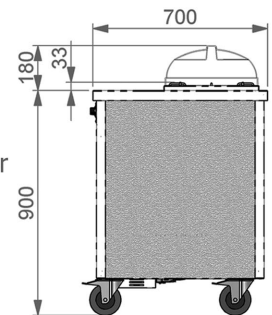

Heated Plate Disp.

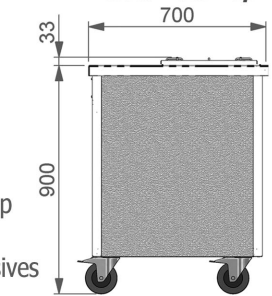

Ambient Plate Disp.





# R290 : Glide Refrigerant Servicing Information



## A) Manufacturers Contact Details

CED Fabrications Ltd, Units A1 - A4 Falcon Court, Clayton Business Park, Clayton-Le-Moors Hyndburn, Lancashire, BB5 5JD Tel. +44(0) 254 238 282 Fax. +44(0)1254 238 228

## B) Refrigerant Leak - Switching Off The Chilled Display

If a sweetish smelling gas is present, this may indicate that refrigerant has leaked. Before investigation by an R290 certified service engineer, the display should be switched off by pressing the blue **On / Off** button. The LED controller will display 'Off' for approx. 5 seconds & a red 'stand by' light will switch on above the **On / Off** button.

**\* Do not isolate the display by turning off at the mains electrical supply. There may be a potential for spark ignition of the refrigerant from a source nearby to the display.\***

## C) Location Of Model UKCA/CE Identification Label.

On completion of manufacturing and testing, a waterproof UKCA/CE label is applied to the product.

**On hot models**, the UKCA/CE label is fitted to the valance panel, at the opposite end to the Glide control panel.



Bain Marie H. Cupbd.

OR

Ceran Top H. Cupbd.

**On cold models**, the UKCA/CE label is fitted to the valance panel, at the opposite end to the Glide control panel.



Cold Well

OR

Cold Multideck

## D) Batch Numbering/Model Identification System - Label Layout

Individual end of line safety electrical load testing (& refrigeration charge / leak testing for cold models) is carried out on completion prior to affixing of ID label:

Model stock code      Customer Specific Job Number

Refrigerant Details: Refrigerant Gas, System Charge, Test & Allowable Pressures

Electrical Supply Requirements: Voltage, Phase, Frequency, Power & Fuse rating of model

CED Fabrications Ltd. Tel: 01254 238 282 Fax: 01254 238 228		UK CA CE	
SERIAL No. [ ]			
MODEL [ ]	REFRIGERANT [ ]	CHARGE [ ]	g
TEST PRESSURE [ ]	bar	ALLOWABLE PRESSURE [ ]	bar
VOLTAGE [ ]	V Ph [ ]	Hz 50-60	POWER [ ] kW FUSE [ ] A
REFRIG. Q.C. [ ]	ELEC. Q.C. [ ]	DATE [ ]	[ ]

Refrigeration & Electrical Testers Employee Nos.      Date Of Completion

## E) Additional Labelling For R290 Refrigerated Units.

In addition to the CE label above, all R290 (propane) refrigerated units are fitted with the adjacent yellow warning label.

## F) R290 Warning Information

The compressor and the receiver are both also marked to indicate R290 refrigerant.

The unit is designed for use with R290 refrigerant.

**Do not** substitute with other refrigerant types. Substitution should not be made without the approval of a competent person. Do not exceed the **unit charge** (grams) when replacing refrigerant.

## G) Transportation Of The Display

These R290 hydrocarbon products can be transported by road, rail or sea within UK, Europe & Non European destinations. They are exempt from European/ Non European legislation relating to the carriage of dangerous goods. (CDGR 1996, ADR 1999, UNMRTDG 1999, IMDG 2001) due to charge levels. They may only be transported by air uncharged for refrigerant charging on site.



**WARNING - R290 Flammable Refrigerant**

- \* Servicing engineers must have appropriate R290 gas handling certification.
- \* Disconnect from electrical supply prior to repair.
- \* Halide torches, or any other detector utilising naked flames, must not be used.
- \* All electrical components must be exchanged like for like.
- \* Do not use mechanical devices or other means to accelerate the defrosting process.
- \* Keep ventilation openings in the appliance enclosure clear of obstruction.
- \* See CE plate, located on electrical junction box lid, for model specific technical information.



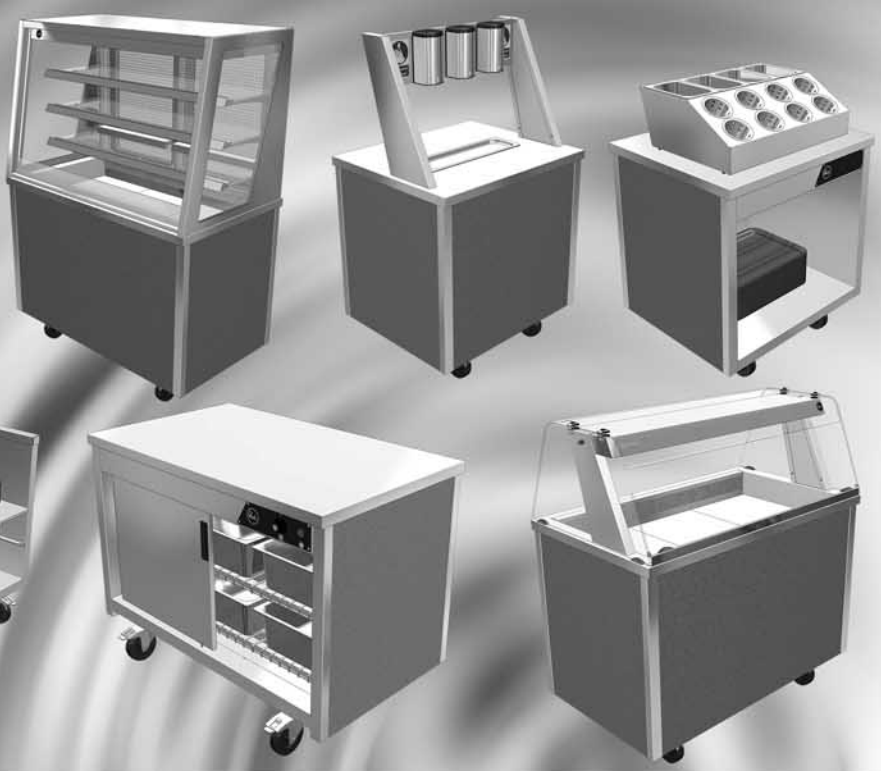

# Mobile Dining Carts



CED Fabrications Limited (Head Office), Units A1-A4 Falcon Court  
Clayton Business Park, Clayton-Le-Moors, Hyndburn, Lancashire BB5 5JD



Tel : 01254 238 282  
[www.cedfabsltd.co.uk](http://www.cedfabsltd.co.uk)  
[sales@cedlimited.com](mailto:sales@cedlimited.com)